

KAWAI



DIGITAL WAVE MEMORY SYNTHESIZER

KE3

OWNER'S MANUAL

1. Parts and Connections

1.1 Names of Parts

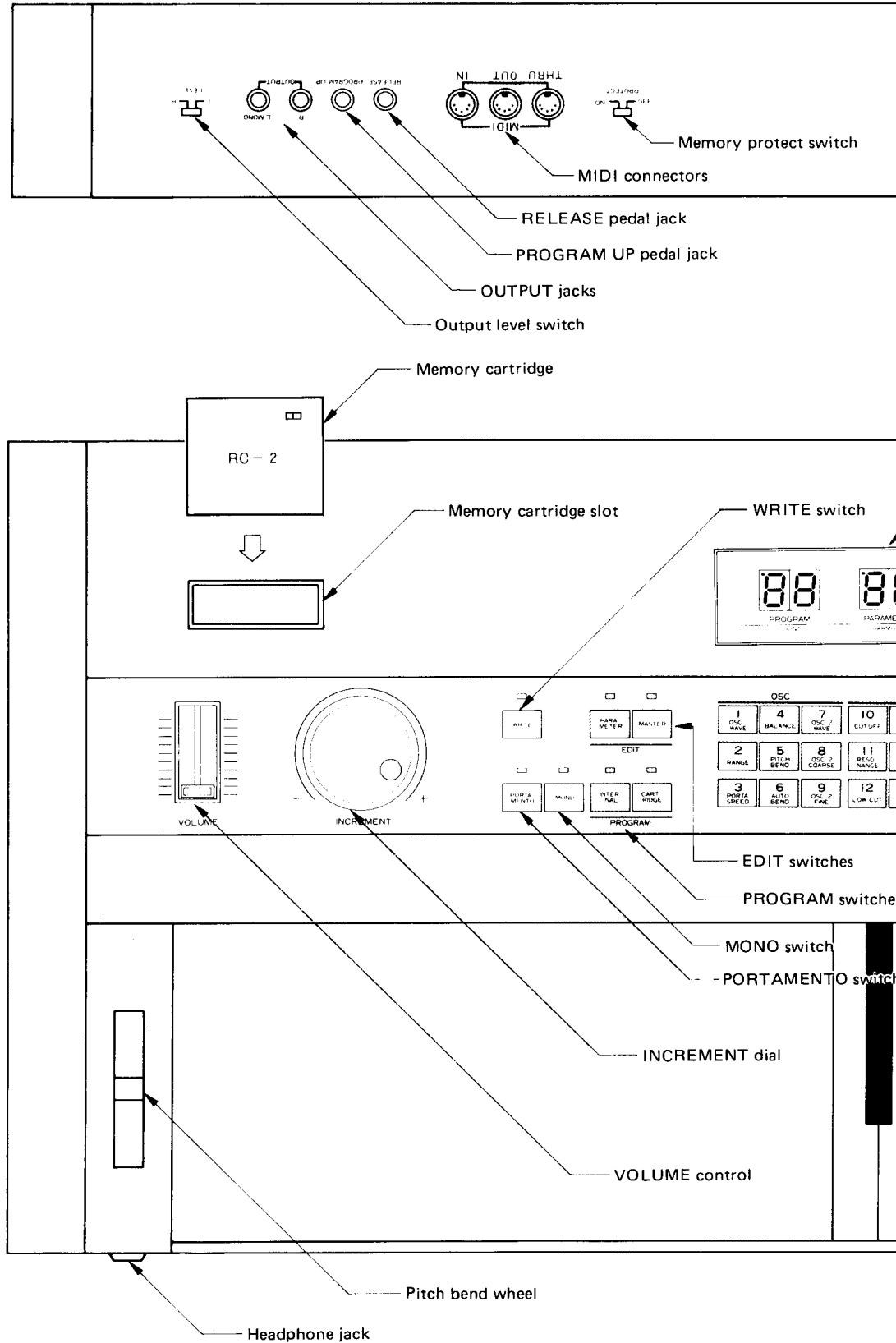

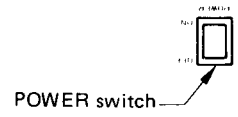

LED display



KAWAI K3

DIGITAL WAVE MEMORY SYNTHESIZER

VCA			LFO		TOUCHSENS		KCV	MASTER			
16	19	22	25	28	31	34	37	40	43	46	49
LEVEL			SHARP	OSC	VELD	PRES	VCF	DC	SEND	HARMON	NAIF
					VCF	VCF		ENV	ENV	TYPE	
17	20	23	26	29	32	35	38	41	44	47	50
SUSTAIN	ATTACK	SUSTAIN	SPEED	VCF	VELD	PRES	VCA	GAIN	EACLU	OP+	LOAD
					VCA	VCA			TYPE		
18	21	24	27	30	33	36	39	42	45	48	LINK
RELEASE	DECAY	RELEASE	DELAY	VIA	PRES	PRES	LHORN	FUNC	EACLU	ERASE	TUNE
					OSC BAL	LFO OSC		MOD	TYPE		

PROGRAM/PARAMETER selector switches

LINK/TUNE switch

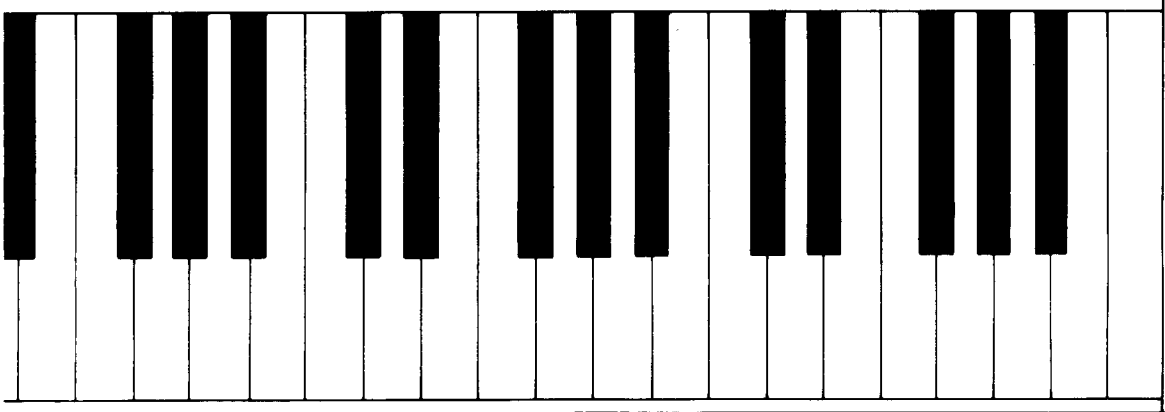

Care and Maintenance

For proper care, protect your K-3 from:

- Direct sunlight and exposure to the elements
- Temperature and humidity extremes
- Unstable or “noisy” AC power
- Dust and sand
- Vibration during transport

Power Supply

- Use a supply within the stated voltage limits.
- Make sure that all power switches are off before changing equipment connections.
- Connect the synthesizer as shown on p. 3.

Cleaning

- Clean the instrument with a soft cloth, a mild detergent, and lukewarm water.
- Never use harsh or abrasive cleansers or organic solvents.

Helpful Hints

■ Battery Backup

The lithium battery protecting the memory contents while the power supply is off is good for more than five years of normal use. We recommend, however, that you have your nearest authorized service representative replace it promptly after five years have passed.

■ Line Noise Reset

In the unlikely event of a “lockup” due to line interference, simply turn the K-3 synthesizer off for a few seconds and then reapply the power.

■ Repairs

Always save the INTERNAL tone patches to a memory cartridge before taking the synthesizer in for repairs or servicing. Otherwise, they may be lost in the course of testing.

■ Avoiding Surges

Always turn equipment off before connecting and disconnecting it.

Table of Contents

1. Parts and Connections	1
1.1 Names of Parts	1
1.2 General Connection Information	3
2. Selecting a Tone Patch	4
2.1 Tone Patch Numbers	4
2.2 Panel Controls	4
2.3 Procedure	5
3. Editing Tone Patch Data	6
3.1 Parameters and Values	6
3.2 Panel Controls	7
3.3 Procedure	8
3.4 Comparing Edit to Original Patch	9
3.5 Parameters and Their Values	9
3.6 Storing Tone Patch Data	24
4. User-Defined Waveforms	25
4.1 Theory	25
4.2 Procedure	26
5. Performance Functions	36
5.1 LINK	36
5.2 TUNE	38
5.3 PITCH BEND Wheel	38
5.4 INCREMENT Dial	38
5.5 PORTAMENTO Switch	39
5.6 MONO Switch	39
5.7 RELEASE Pedal	39
5.8 PROGRAM UP Pedal	39
5.9 VELOCITY SENS	40
5.10 PRESSURE SENS	40
6. Saving and Loading Data	41
6.1 SAVE	41
6.2 LOAD	42
7. MIDI Interface	43
7.1 Typical Connections	43
7.2 The K-3 MIDI Implementation	44
8. Specifications	50

Introduction

Congratulations! You are now the owner of one of the world's most technologically advanced digital keyboards, the Kawai K-3 Digital Wave Memory Synthesizer. The K-3 is a truly outstanding value combining advanced microelectronics technology, innovative performance features, and superior sound quality. Your K-3 is an investment in digital synthesis technology that will provide you with many years of musical enjoyment.

A New Approach to Sound Synthesis

The Kawai K-3 synthesizer combines wave sampling technology with true synthesis ability for a totally new approach to sound generation. It starts by constructing the waveform for a digital sound source from its harmonic components. (There are 32 such waveforms built into the synthesizer, but you can program your own by assigning relative amplitudes for any 32 of the first 128 harmonics.) The audio signals from each oscillator are then combined and passed through filters, LFOs, envelope generators, and other components usually found only in today's more advanced analog synthesizers.

Wave sampling yields very faithful reproduction of the original because it produces a highly accurate description of sound produced by a piano, trombone, bass guitar, or any other instrument. The technology used, however, calls up a fixed sample and plays it back in a fashion not unlike a tape recorder. Using such a fixed sound source sacrifices control over the articulation, the way in which the sound varies over time after the musician first strikes the key. Analog synthesizers, on the other hand, generally provide greater control over articulation and other parameters required to produce a more "live" sound — only to lose sampling accuracy and the ability to easily program the synthesizer to emulate an existing instrument. The Kawai K-3 synthesizer's digitally programmed sound sources give you the best of both worlds: lifelike samples and complete control of articulation.

Other Features

The Kawai K-3 synthesizer has several other advanced features as well:

- Programmable velocity and aftertouch (pressure), that allow you to personalize keyboard response for each tone patch
- Programmable stereo chorus and delay for creating tone patches with realistic, studio quality effects
- Weighted keyboard for a professional "feel" and accurate touch response
- Slot for a removable memory cartridge, an external storage device which holds 50 additional tone patches
- Advanced MIDI implementation including support for "system exclusive" messages which expand the control possible with this world standard interface.
- Analog and digital sound synthesis — the best of both worlds!

Do not let all these advanced features overwhelm you. The Kawai K-3 synthesizer also has many of the standard features which you already know how to use. (See "In a Hurry?" below.) We do suggest, however, that you study this manual and keep it handy as a reference so that you can get the most from the wide range of advanced features available to you.

Note: The abbreviation LED stands for "light-emitting diode" and, when used as a noun, refers to the on/off status indicator located just above a front panel control switch. (Larger LEDs are used to form letters and digits on the LED display above these switches.)

In a Hurry?

(1) To play:

- Carefully unpack your new K-3 and plug the AC cord into a power outlet with the proper voltage.
- Plug a set of stereo headphones into the jack provided (on the front edge, at the left) or connect the audio output jacks (left for mono; both for stereo) on the rear panel to an amplifier.
- (Optional) Connect appropriate MIDI cables to the MIDI OUT (K-3 as master) or MIDI IN (K-3 as slave) jack on the rear panel.
- Turn on the synthesizer. (The LED next to the PROGRAM INTERNAL switch should light; the PROGRAM/COUNT part of the LED display should read "1".)
- Select a tone patch number: INTERNAL or CARTRIDGE plus one of the fifty numbered keys to the right of the control switches.
- Adjust volume and play.

(2) To program a patch:

- Select the number for a tone patch to edit.
- Press the PARAMETER switch. (The LED next to it will light.)
- Select a parameter from the fifty numbered keys to the right of the control switches. (The parameter number will appear in the PARAMETER/HARMONIC part of the LED display.)
- Turn the INCREMENT dial to adjust the VALUE/INTENSITY part of the LED display.
- Turn the PARAMETER switch on and off to compare the effects of the edited and unedited versions on keyboard output.

(3) To store an edited patch:

- Turn off the memory protect switch on the rear panel (INTERNAL patch) or the memory cartridge.
- Press the WRITE switch. (The LED next to it will light.)
- Select a tone patch number for the edited version. Either write over the old patch by re-entering the original patch location, or enter a new tone patch location. (The LED next to the WRITE switch will go out.)
- Turn on the appropriate memory protect switch.

1.2 General Connection Information

Note: Always connect and disconnect equipment with all power switches off.

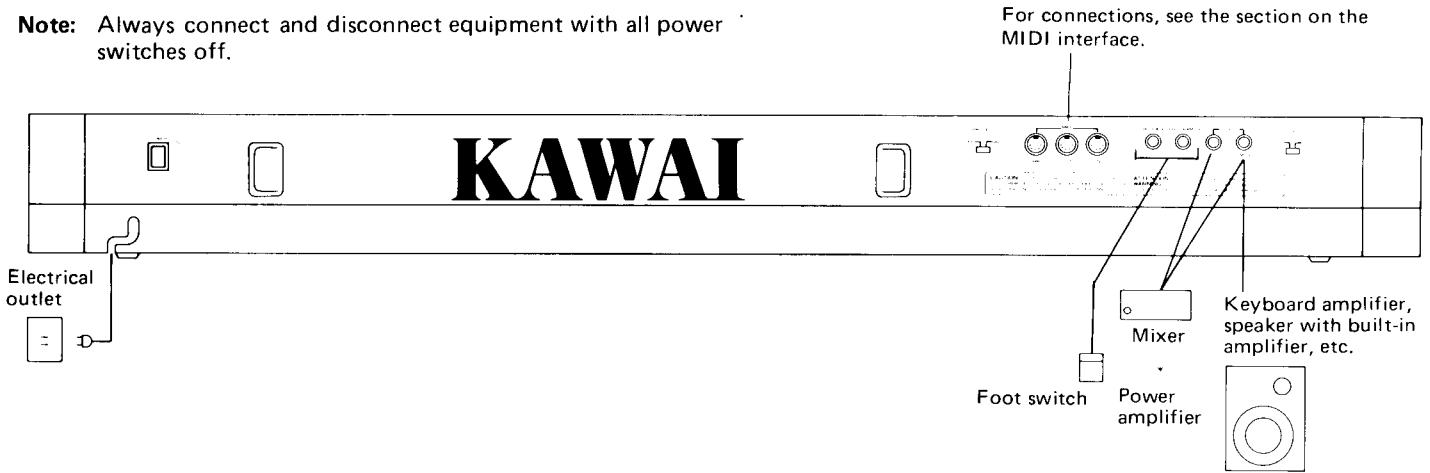

■ OUTPUT jacks

The K-3 contains no amplifier or speakers — only a headphone jack for private listening and these line outputs for connection to a keyboard amplifier, public address system, or other audio system. (Use the stereo output for a richer chorus effect.)

■ LEVEL switch

This switch provides a choice of two output levels. Choose the one best matching the amplifier characteristics:

- HIGH — for power amplifiers, audio mixers, and other equipment with input attenuation
- LOW — guitar and other sensitive amplifiers with high gain

■ PROGRAM UP pedal jack

A foot switch connected to this jack allows you to change tone patch programs without taking your hands from the keyboard.

■ RELEASE pedal jack

A foot switch connected to this jack allows you to turn the damper pedal effect, which controls the amount of time it takes sound to fade after the key is released, on and off.

■ MIDI connectors

These accept cables joining the synthesizer to other MIDI instruments. (For a more detailed description, see the section on the MIDI interface.)

■ PROTECT switch

The normal position of this switch is ON, where it protects the memory contents from accidental erasure or overwriting. It must be in the OFF position if you want to save an edited patch or copy tone patches from a memory cartridge.

■ Memory cartridge

The K-3 comes with one memory cartridge as standard equipment. When inserting a cartridge in the slot provided in the upper left hand corner, first place the cartridge's memory protect switch in the ON position. Make sure that the switch is pointing forward (towards you) and then press firmly into place.

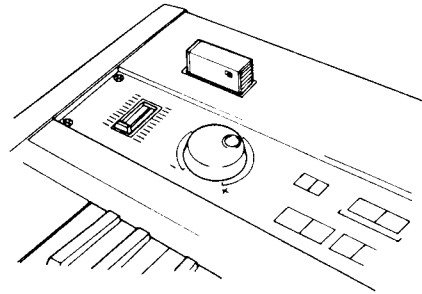

■ PHONE jack (stereo)

Plug a set of headphones in this jack for private listening.

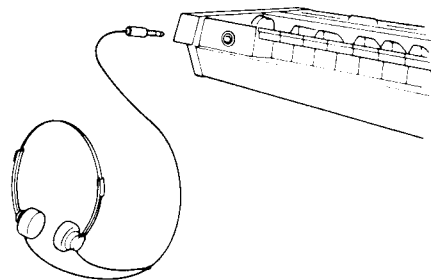

2. Selecting a Tone Patch

2.1 Tone Patch Numbers

The K-3 holds fifty tone patches in its internal memory and another fifty in a removable memory cartridge. Changing tone patches is as easy as pressing two switches.

2.2 Panel Controls

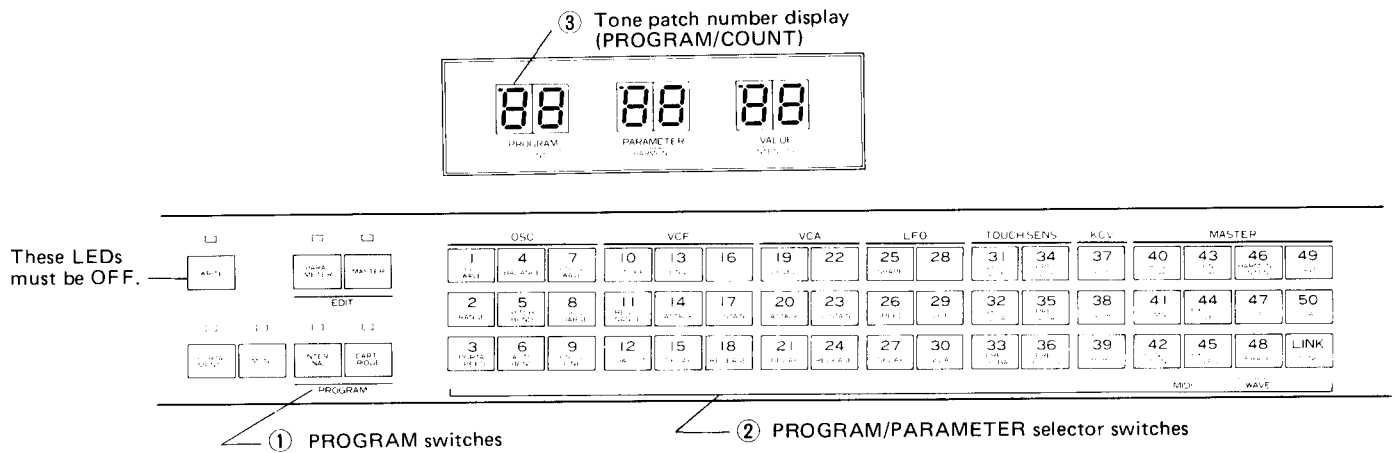

Note:
The Guide Sheet included with your K-3 lists the names of the 100 factory-installed patches. Choose your favorite and use the K-3 editing facilities to modify it to suit your taste. Do not, however, touch the WRITE switch until you are thoroughly familiar with your K-3.

Note:

- The stock factory set of fifty INTERNAL tone patches can always be restored by holding down the first three keys (C, C#, and D) as you turn on the power. You may, however, first want to copy the current patches to a cartridge so that you do not lose your custom patches.

2.3 Procedure

(1) Press the appropriate PROGRAM switch (INTERNAL or CARTRIDGE) so that the LED next to it lights.

(2) Make sure that the two EDIT switches and the WRITE switch are OFF. (If the LED next to one of these three switches is lit, press the switch to turn it off.)

Note: The above two steps can be done in either order.

(3) Press one of the PROGRAM/PARAMETER selector switches (numbered 1-50 and located to the right of the control switches) to change the synthesizer's tone patch. (The first two digits of the LED will give, in orange, the tone patch number.)

Note:

- Pressing the CARTRIDGE switch at this point will not affect the tone patch. The INTERNAL LED will go out, but the CARTRIDGE LED will flash until you press a PROGRAM/PARAMETER selector switch. The LED will then light steadily to indicate that the change has been made and that you are currently using a tone patch from the memory cartridge.

Note:

- If the LED display changes **C E R R O R** ("Cartridge Error"), the cartridge is missing or not firmly in place. Reinsert the cartridge and repeat the selection procedure.

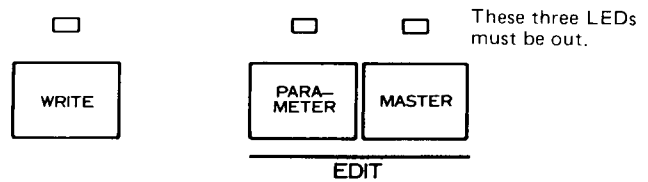
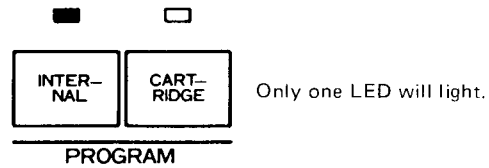

Example

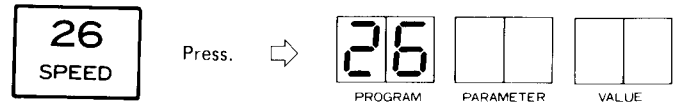

These three steps change the tone patch to that stored as internal tone patch #26.

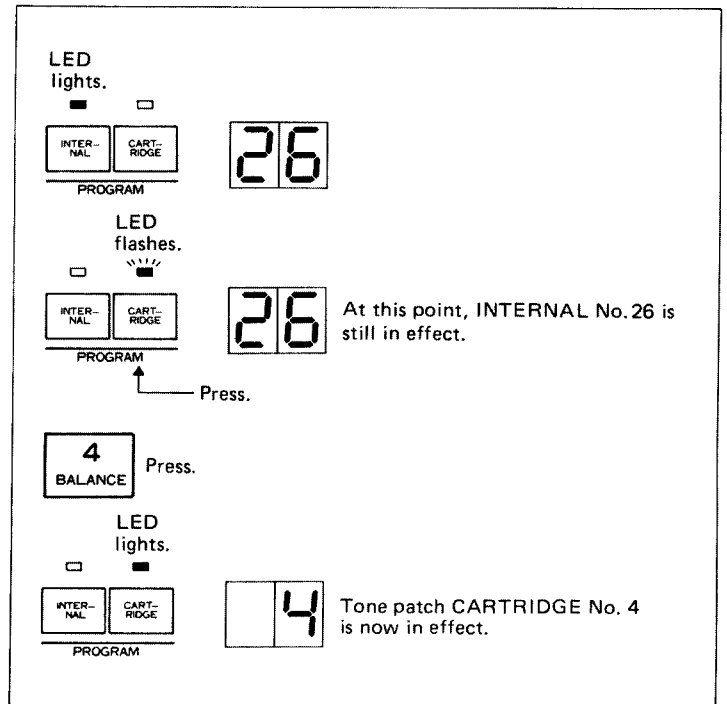

3. Editing Tone Patch Data

The K-3 makes it easy for you to create a distinctive sound because it provides 100 readymade patterns that can act as starting points. All you have to do is choose the one closest to the desired sound and then adjust the parameters — a process that takes much less time than starting from scratch.

This editing capability extends even to the waveform used as the sound source. More advanced users will appreciate the greater freedom of expression possible with the programmable digital waveform feature.

The results of your editing can even be saved, either in the synthesizer's internal memory or in a removable memory cartridge, for future use. (See "Storing Tone Patch Data" on p. 24.)

3.1 Parameters and Values

On a synthesizer, a particular tone patch is described in terms of "parameters" — components such as range, filter cutoff, and amount of resonance, for example — and "values", the numbers assigned to each parameter. On the K-3, the value for a parameter is limited to a particular range of numbers (0-31, 0-99, etc.). Increasing or decreasing the value for a particular parameter changes the sound or the effect that parameter has on the sound.

3.2 Panel Controls

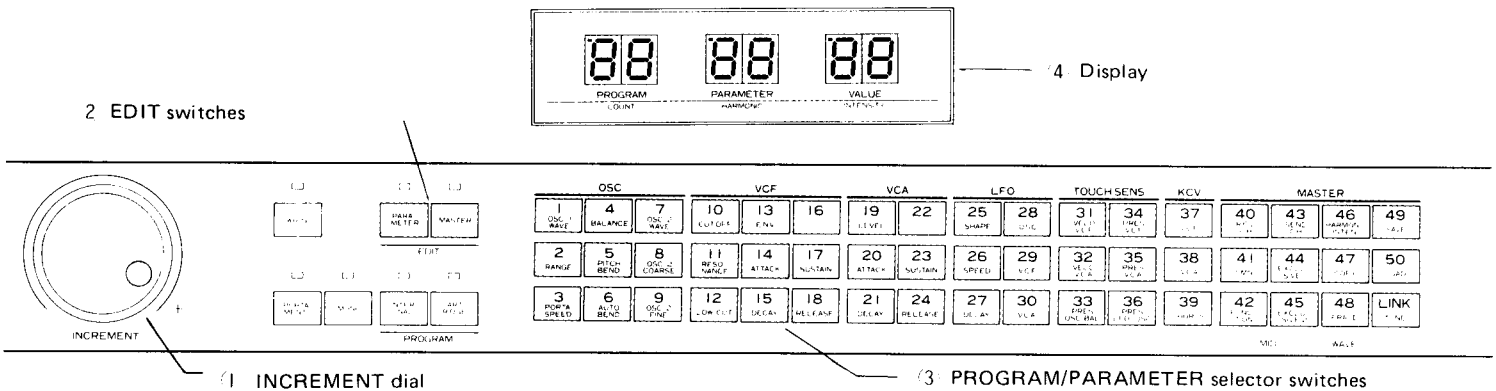

1 INCREMENT dial

Turning this dial clockwise increases the value assigned to a parameter; turning it counterclockwise decreases the value.

2 EDIT switches

To edit tone patch parameters, press the PARAMETER switch so that the LED next to it lights.

Note: The MASTER switch is used for more advanced types of editing: setting the instrument's MIDI channels, editing a sound source waveform, and transferring data between the internal memory and the memory cartridge. The two LEDs will never light simultaneously. To turn off the LED, press the corresponding switch. If either LED is lit, the instrument is in the edit mode.

Note: The PARAMETER switch also provides a compare function which allows you to compare the current, edited sound with the original. (See p. 9.)

3 PROGRAM/PARAMETER selector switches

When the LED next to the PARAMETER switch is lit, switches 1-39 function as parameter selector switches. The others (switches 40-50) only function when the LED next to the MASTER switch is lit.

4 Display

The display consists of three pairs of digits:

PROGRAM/COUNT	tone patch number
PARAMETER/HARMONIC	parameter number
VALUE/INTENSITY	current parameter value

Example

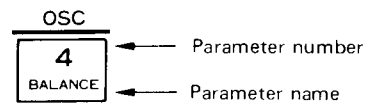

Tone patch number (orange)

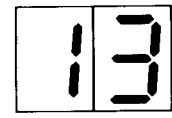

Parameter number (red)



Parameter value (red)

3.3 Procedure

- (1) Select the tone patch closest to the desired effect.
- (2) Press the PARAMETER switch so that the LED next to it lights and the parameter last edited and its value appear on the display.

- (3) Press a parameter selector switch so that the parameter number and its current value appear on the LED display.

- (4) Turn the INCREMENT dial clockwise to increase the value, counterclockwise to lower it.

Note: It is also possible, by turning the PARAMETER switch on and off, to compare the current tone patch with the original.

- (5) Repeat steps (3) and (4) as often as necessary.

Note: Changing the tone patch number without saving the edited values erases the edited tone patch data. It is also possible to store the new tone patch for later use. (See "Storing Tone Patch Data" on p. 24.)

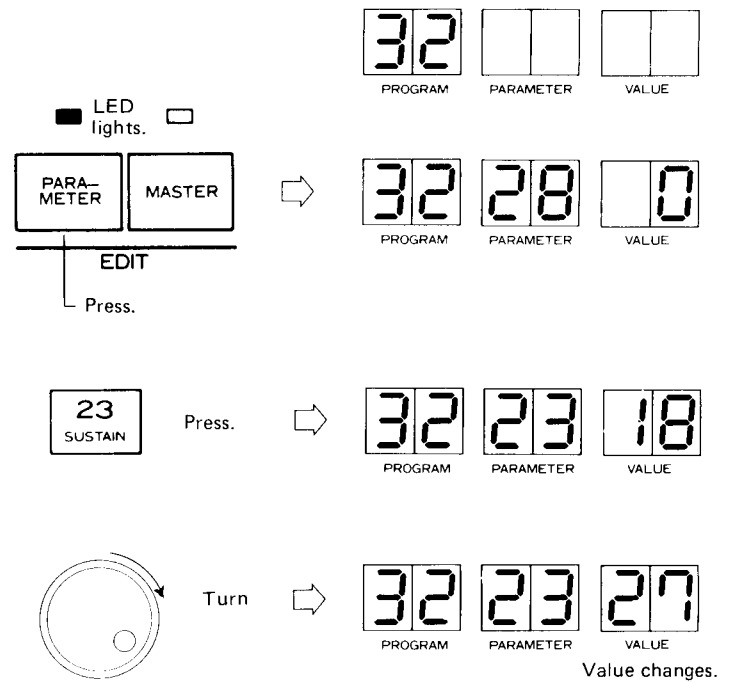

3.4 Comparing Edit to Original Patch

The original tone patch is always available at any stage of the editing session. Simply pressing the PARAMETER switch and turning off the LED next to it returns the synthesizer to the original tone patch. At the same time, the value on the display also changes to the original one. Pressing the switch a second time relights the LED and returns the synthesizer to the tone patch and the parameter value as it was last edited.

Note: If the LED next to the PARAMETER switch is OFF, the synthesizer will store the original patch – NOT the edited version. Similarly, if you use the INCREMENT dial to alter the tone patch while playing, the synthesizer will store the new version, not the old.

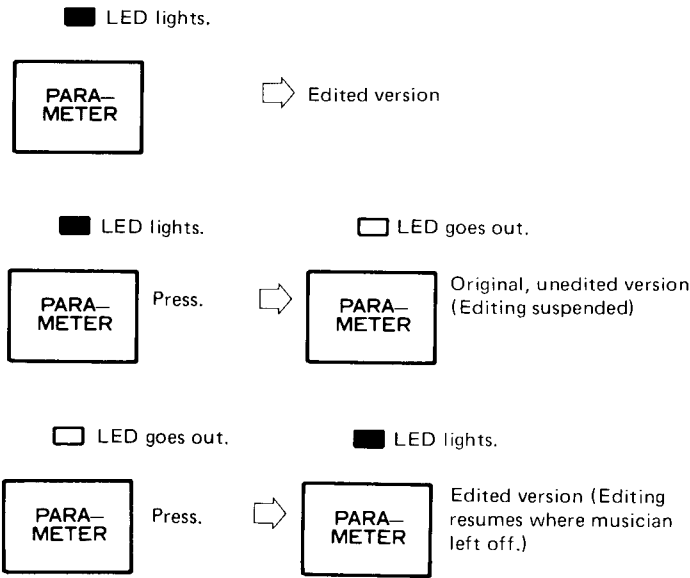

3.5 Parameters and Their Values

The following pages list the K-3's programmable tone patch parameters, their meanings, and their possible values. Each tone patch program represents a particular combination of such values.

OSC

1 OSC 1 WAVE	4 BALANCE	7 OSC 2 WAVE
2 RANGE	5 PITCH BEND	8 OSC 2 COARSE
3 PORTA SPEED	6 AUTO BEND	9 OSC 2 FINE

[OSC]

#1. OSC 1 WAVE (0 to 33)

This parameter specifies the wave source for oscillator No. 1.

Value	Wave source
0	Cancel (no sound)
1	} Factory preset waveforms
2	
31	
32	User-defined waveform (internal or memory cartridge)
33	White noise

#2. RANGE (16/8/4)

This parameter offers, in 1-octave steps, a choice of three pitch ranges for the two oscillators.

Value	Range
16	16 feet (Bass)
8	8 feet (Mid-range)
4	4 feet (Treble)

#3. PORTA SPEED (0 to 99)

This parameter controls the speed with which the pitch changes between notes. This effect is designed to smooth transitions for legato playing.

Value	Portamento speed
0	Fastest possible portamento
1	}
99	Slowest possible portamento

Note: This effect applies only when the PORTAMENTO switch is on. (This switch setting is also stored with the tone patch data.)

#4. BALANCE (-15 to 15)

This parameter determines the mixing balance for the two oscillators.

Value	Mixing balance
15	Oscillator No. 1 only
1	}
0	Even
1	}
15	Oscillator No. 2 only

#5. PITCH BEND (1 to 7)

This parameter determines the range, in semitones, covered by the PITCH BEND wheel.

Value	Pitch bend range
1	± semitone
1	}
7	± perfect fifth

#6. AUTO BEND (-31 to 31)

This parameter determines the amplitude and direction of the glide added to the beginning of each note. The AUTO BEND function does not apply to legato playing.

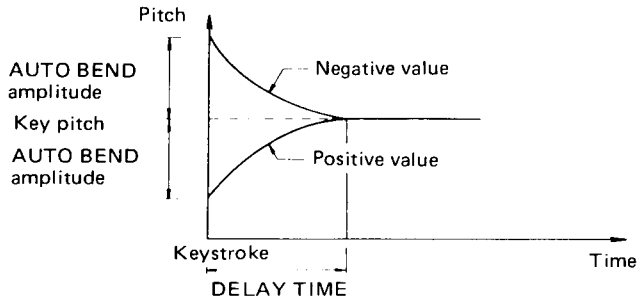

Note: The delay time (the time required to complete the glide) is determined by parameter #27, LFO DELAY TIME.

#7. OSC 2 WAVE (0 to 33)

This parameter assigns a waveform to oscillator No. 2 just as parameter #1 assigns one to oscillator No. 1.

#8. OSC 2 COARSE (-24 to 24)

This parameter tunes, in semitones, oscillator No. 2 relative to oscillator No. 1 over a range of two octaves above and below.

#9. OSC 2 FINE (-10 to 10)

This parameter fine-tunes the pitch derived from parameter #8 OSC 2 COARSE. Adjusting the pitch this way adds depth to the sound.

Value	PITCH BEND effect
31	The pitch glides upward to that of the key pressed.
}	}
0	No glide.
}	}
31	The pitch glides downward to that of the key pressed.

Value	OSC 2 pitch relative to OSC 1
24	2 octaves lower
}	}
0	Same
}	}
24	2 octaves higher

Value	OSC 2 pitch relative to OSC 1
10	30 cents lower
}	}
0	Same
}	}
10	30 cents higher

VCF

10 CUTOFF	13 ENV	16
11 RESO- NANCE	14 ATTACK	17 SUSTAIN
12 LOW CUT	15 DECAY	18 RELEASE

[VCF]

#10. CUTOFF (0 to 99)

This parameter determines the cutoff frequency for the low-pass filter. As the name should suggest, this filter passes all frequencies below the cutoff point and filters out those above. (See diagram below.) Lowering the value (and hence the cutoff frequency) cuts off the higher harmonics.

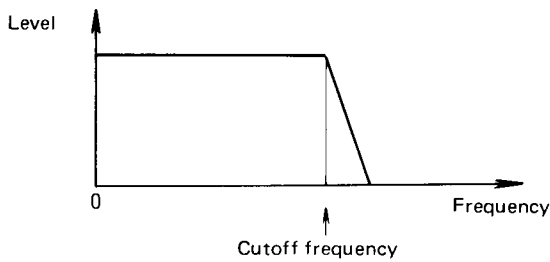

#11. RESONANCE (0 to 31)

This parameter controls the amount of resonance (emphasis) added to the cutoff frequency. Increasing the resonance enhances the harmonics in this region. The maximum value (31) produces self-oscillation, a filter effect which can be used as a sound source (oscillator) for special effects.

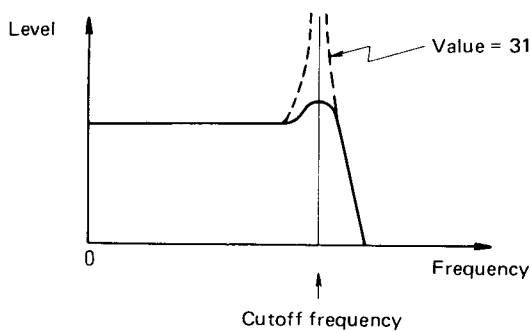

Value	Tone effect
0	Softer (All frequencies cut out)
99	Brighter (All frequencies passed)

Value	Amount of resonance
0	None
31	Maximum (Self-oscillation)

#12. LOW CUT (0 to 31)

This parameter determines the cutoff frequency for the high-pass filter, a filter which passes all frequencies above the cutoff point and attenuates all frequencies below that point. (See diagram below.) Raising the value (and hence the cutoff frequency) cuts out the bass component of the sound.

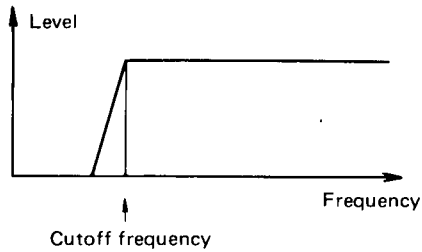

#13. ENV Amount (0 to 31)

This parameter determines how much the VCF envelope generator (parameters #14, #15, #17, and #18 below) affects the filter output. (See diagram below.) Increasing the value makes the VCF-EG effect more pronounced.

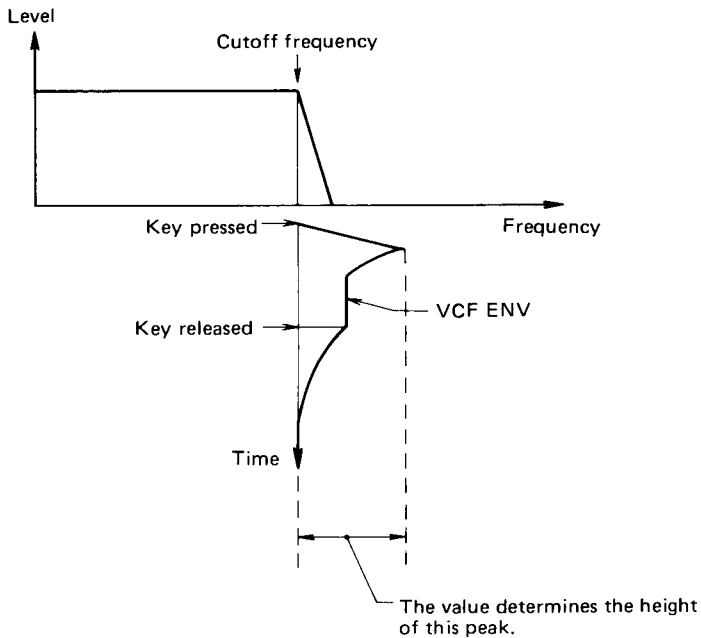

Value	Effect on lower frequencies
0	No filtering (All frequencies passed.)
31	Maximum filtering

Value	Tone dependence on time
0	None
31	Maximum

VCF

10 CUTOFF	13 ENV	16
11 RESO- NANCE	14 ATTACK	17 SUSTAIN
12 LOW CUT	15 DECAY	18 RELEASE

#14. ATTACK (0 to 31)

This parameter determines the VCF envelope's attack time, the time required to reach the peak of the envelope.

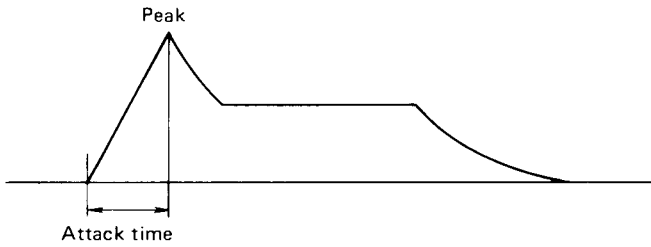

The height of the peak is determined by parameter #13 (ENV Amount). The higher the amount (peak), the more the low-pass filter cutoff frequency varies with time.

#15. DECAY (0 to 31)

This parameter determines the VCF envelope's decay time, the time required to drop from the peak to the sustain level. The larger this value, the longer the decay time.

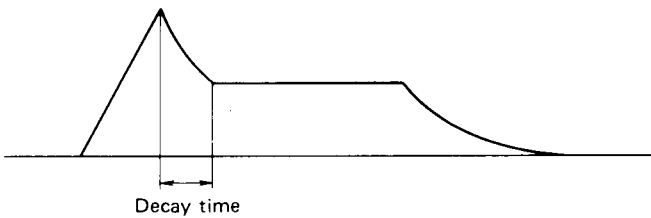

#16. (Vacant)

No parameter has been assigned to this switch. Pressing it will have no effect on the tone patch.

Value	Attack time
0	Shorter
}	}
31	Longer

Value	Decay time
0	Shorter
}	}
31	Longer

#17. SUSTAIN (0 to 31)

This parameter determines the VCF envelope's sustain level, the level which follows the decay and lasts as long as the key is depressed.

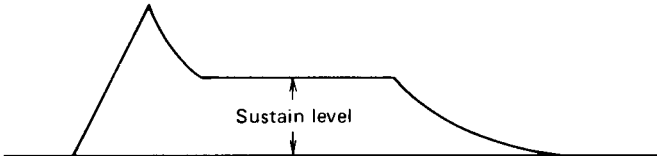

Note: Since the sustain level is defined relative to the peak level, setting it to the maximum (31) eliminates the decay.

Value	Sustain level
0	0
1	1
31	Maximum

#18. RELEASE (0 to 31)

This parameter determines the VCF envelope's release time, the time required for the sound level to drop from the sustain level to "0" after the key is released. The greater the value, the longer the sound takes to die out completely.

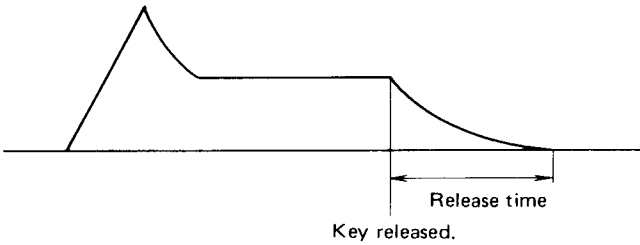

Value	Release time
0	Shorter
1	1
31	Longer

VCA

19 LEVEL	22
20 ATTACK	23 SUSTAIN
21 DECAY	24 RELEASE

[VCA]

#19. LEVEL (0 to 31)

This parameter allows you to control the output level for individual tone patches. The other parameters in this section (#20, #21, #23, and #24) determine the shape of the envelope used to introduce a time dependence to the level of individual notes. (See parameters #13, #15, #17, and #18 for a more detailed explanation.)

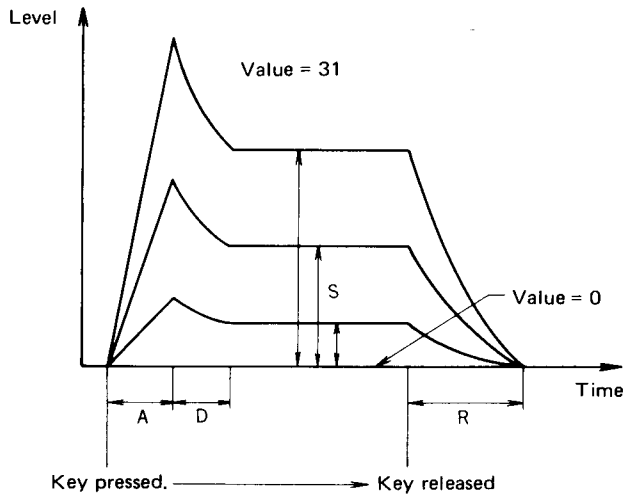

- A : Attack time
- D : Decay time
- S : Sustain level
- R : Release time

Note: A value of "0" produces no output.

Value	Level
0	0
}	}
31	Maximum

#20. ATTACK (0 to 31)

This parameter determines the attack time for the VCA envelope. A value of "0" produces the quickest possible rise.

Value	Attack time
0	Shorter
}	}
31	Longer

#21. DECAY (0 to 31)

This parameter determines the decay time for the VCA envelope. A value of "0" produces the quickest drop to the sustain level.

Value	Decay time
0	Shorter
}	}
31	Longer

LFO

25 SHAPE	28 OSC
26 SPEED	29 VCF
27 DELAY	30 VCA

#22. (Vacant)

No parameter has been assigned to this switch. Pressing it will have no effect on the tone patch.

#23. SUSTAIN (0 to 31)

This parameter determines the sustain level for the VCA envelope. Setting it to "0" eliminates the sustain effect so that the level decays all the way to "0" from the peak. Setting it to "31", on the other hand, eliminates the decay so that the sustain level is the same as the peak level.

Value	Sustain level
0	0
}	}
31	Maximum

#24. RELEASE (0 to 31)

This parameter determines the release time for the VCA envelope. The greater the value, the longer the sound takes to die out after the key is released.







Value	Release time
0	Shorter
}	}
31	Longer

[LFO]

#25. SHAPE (1 to 7)

This parameter determines the waveform for the LFO output.

Note: The seventh one, chromatic random, introduces random pitch variations in semitone steps to produce a vibrato effect directly from the oscillator.

Value	Waveform
1	 Triangle
2	 Sawtooth
3	 Reverse sawtooth
4	 Square
5	 Inverted square
6	 Random
7	 Chromatic random

#26. SPEED (0 to 99)

This parameter determines the LFO speed (frequency). The higher the value, the more rapid the modulation effect.

Value	Modulation speed
0	Slower
}	}
99	Faster

LFO

25 SHAPE	28 OSC
-------------	-----------

26 SPEED	29 VCF
-------------	-----------

27 DELAY	30 VCA
-------------	-----------

#27. DELAY (0 to 31)

This parameter determines the amount of time which passes before the LFO modulation begins. The greater the value, the longer the interval between the striking of the key and the start of the LFO modulation.

Note: This delay time is also used by the AUTO BEND function (parameter #6).

#28. OSC (0 to 31)

This parameter determines the amount of vibrato generated by applying the LFO output to the oscillator. The greater the value, the greater the pitch variation introduced.

#29. VCF (0 to 31)

This parameter determines the amount of modulation generated by applying the LFO output to the VCF. The greater the value, the greater the tone variation introduced.

#30. VCA (0 to 31)

This parameter determines the amount of modulation generated by applying the LFO output to the VCA. The greater the value, the greater the level variation introduced.

Value	Delay time
0	"0" (Effect begins immediately.)
31	Longer

Value	Amount of vibrato
0	None
31	Maximum

Value	Amount of tone modulation
0	None
31	Maximum

Value	Amount of level modulation
0	None
31	Maximum

TOUCH SENS

31 VELO VCF	34 PRES VCF
32 VELO VCA	35 PRES VCA
33 PRES OSC BAL	36 PRES LFO-OSC

[TOUCH SENS]

#31. VELO VCF (0 to 15)

This parameter determines the relationship between velocity, the force with which you press the key, and the VCF cutoff frequency.

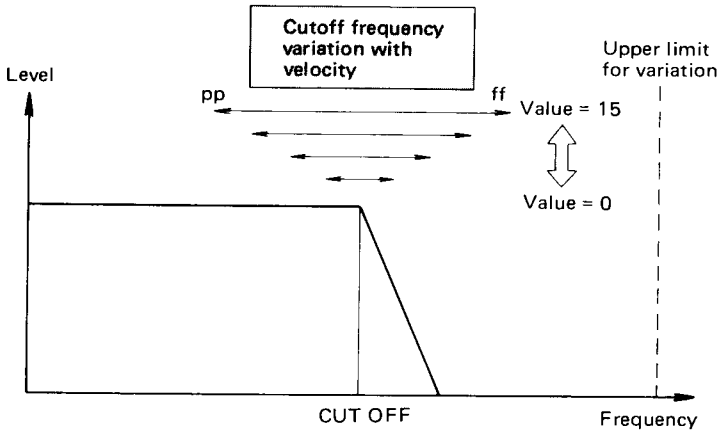

Note: If the maximum setting (15) fails to produce an adequate touch response, adjust parameters #10 (CUTOFF) and #13 (VCF ENV). Too high a value for either parameter severely limits the range of variation possible for the cutoff frequency.

#32. VELO VCA (0 to 15)

This parameter determines the relationship between velocity and the VCA output level.

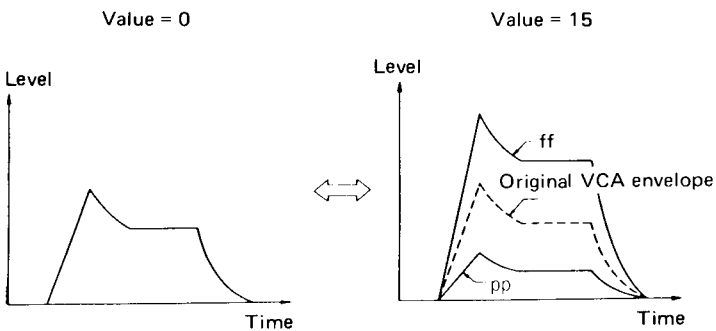

Value	Tone variation with velocity
0	None
}	}
15	Maximum

Value	Level variation with velocity
0	None
}	}
15	Maximum

TOUCH SENS

31 VELO VCF	34 PRES VCF
-------------------	-------------------

32 VELO VCA	35 PRES VCA
-------------------	-------------------

33 PRES OSC BAL	36 PRES LFO-OSC
-----------------------	-----------------------

#33. PRES OSC BAL (0 to 15)

This parameter determines the relationship between key pressure (aftertouch) and the mixing balance between the two oscillators. For a non-zero value, increasing the pressure shifts the balance from the initial one specified with parameter #4 (OSC BAL-ANCE) in favor of oscillator No. 2.

Value	Shift in mixing balance toward oscillator No. 2
0	None
7	?
15	Maximum

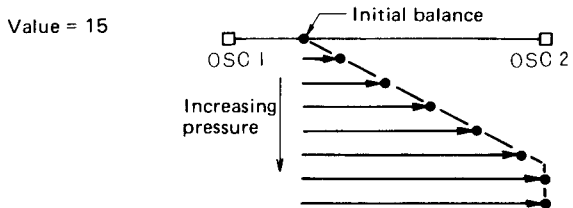
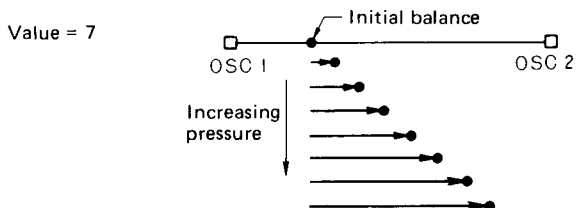
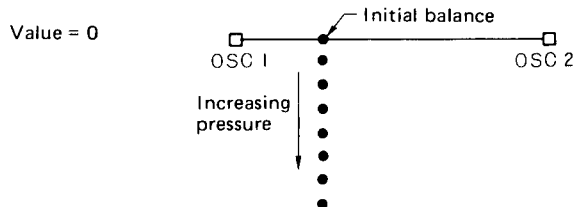

Note: The effect is less pronounced if the initial balance is already heavily shifted in favor of oscillator No. 2.

#34. PRES VCF (0 to 15)

This parameter determines the relationship between key pressure (aftertouch) and the VCF cutoff frequency. For a non-zero value, increasing the pressure raises the frequency and thereby changes the tone patch.

Note: The effect is less pronounced if any of the following parameters have already raised the cutoff frequency beyond the range in which it can be modulated: #10 CUTOFF, #13 ENV, #17 SUSTAIN, or #31 VELO VCF. (In the last case, the effect diminishes after keystrokes which are heavy from the start.)

#35. PRES VCA (0 to 15)

This parameter determines the relationship between key pressure (aftertouch) and the VCA output level. For a non-zero value, increasing the pressure raises the volume.

Value	Tone variation with key pressure
0	None
5	2
15	Maximum

Value	Level variation with key pressure
0	None
5	2
15	Maximum

TOUCH SENS

31 VELO VCF	34 PRES VCF
32 VELO VCA	35 PRES VCA
33 PRES OSC BAL	36 PRES LFO-OSC

#36. PRES LFO-OSC (0 to 15)

This parameter determines the relationship between key pressure (aftertouch) and the amount of vibrato added. For a non-zero value, increasing the pressure raises the amount of vibrato.

Value	Vibrato as a function of key pressure
0	None
7	?
15	Maximum

Value = 0

————— No vibrato

—————>
Increasing pressure



Value = 7



—————>
Increasing pressure



Value = 15

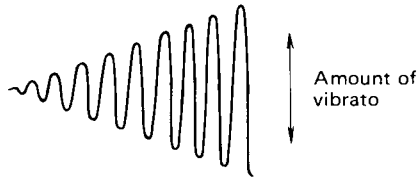

—————>
Increasing pressure

Note: This effect is available even when parameter #28 (LFO OSC) has been set to "0".

[KCV]**#37. VCF (-15 to 15)**

This parameter determines the relationship between the keyboard scale and the VCF cutoff frequency. It is used, for example, to simulate the tendency for the sound of musical instruments to become brighter as the pitch rises.

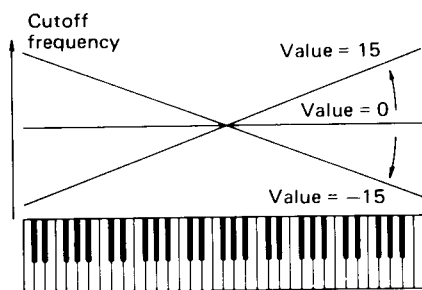
**#38. VCA (-15 to 15)**

This parameter determines the relationship between the keyboard scale and the VCA output level.

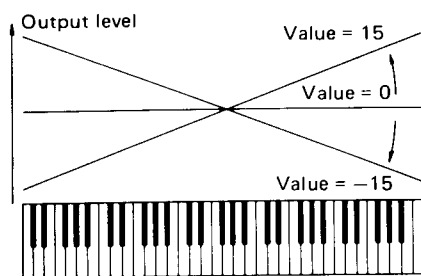
**[CHORUS]****#39. CHORUS (0 to 7)**

This parameter determines the type of chorus or delay added to the tone patch. These stereo effects are built into the K-3 synthesizer and once selected, can be programmed into a tone patch.

- Chorus I : slow choral/phase shift
- Chorus II : combination slow/fast shift
- Chorus III : medium, random shift
- Tremolo : fast, deep, shift
- Chorus IV : ambience (1)
- Chorus V : ambience (2)
- Delay : short (40 - 60 ms)

Note: Use both left and right audio outputs or headphones for best effect.

Value	Cutoff variation as key pitch rises
15	Drops at maximum rate
}	}
0	Does not change
}	}
15	Rises at maximum rate

Value	Level variation as key pitch rises
15	Drops at maximum rate
}	}
0	Does not change
}	}
15	Rises at maximum rate

Value	Chorus effect
0	None
1	Chorus I
2	Chorus II
3	Chorus III
4	Tremolo
5	Chorus IV
6	Chorus V
7	Delay

3.6 Storing Tone Patch Data

The edited tone patch may be saved for future use either in the synthesizer's internal memory or a removable memory cartridge, which provide fifty storage locations each. Storing the data to one of the 100 such locations available at any given time erases the previous contents, however. If this is not desired, you can purchase additional cartridges to hold your growing library of tone patches.

Procedure:

- (1) When you have finished editing, press the WRITE switch so that the LED next to it lights. (The LED next to the PARAMETER switch should also be lit as well.)
- (2) Deactivate the memory protect mechanism by shifting the appropriate PROTECT switch (either on the rear panel of the instrument or on the memory cartridge) to its OFF position.

Note: If the PROTECT switch is left in its ON position, the storing operation will fail, and the message

Pr ot ct ("Protect") will appear on the LED display.

- (3) Press a PROGRAM switch (INTERNAL or CARTRIDGE) and then the PROGRAM/PARAMETER selector switch corresponding to a tone patch that is empty or no longer required. (The LEDs next to the WRITE and PARAMETER switches will go out when the operation is complete.)

- (4) Return the PROTECT switch to its ON position as a precaution against accidental erasures.

Note: This operation stores the current values for all parameters — including those that you have left unchanged or unassigned. It may therefore also be used to store minor changes to tone patches that have been edited "on the fly" during the course of a live performance.

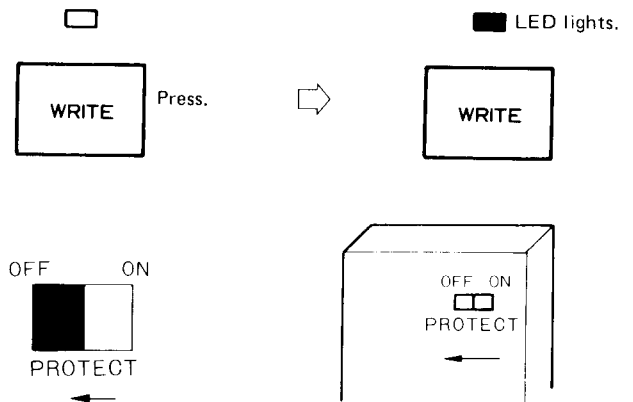

Example: Saving to CARTRIDGE No. 4

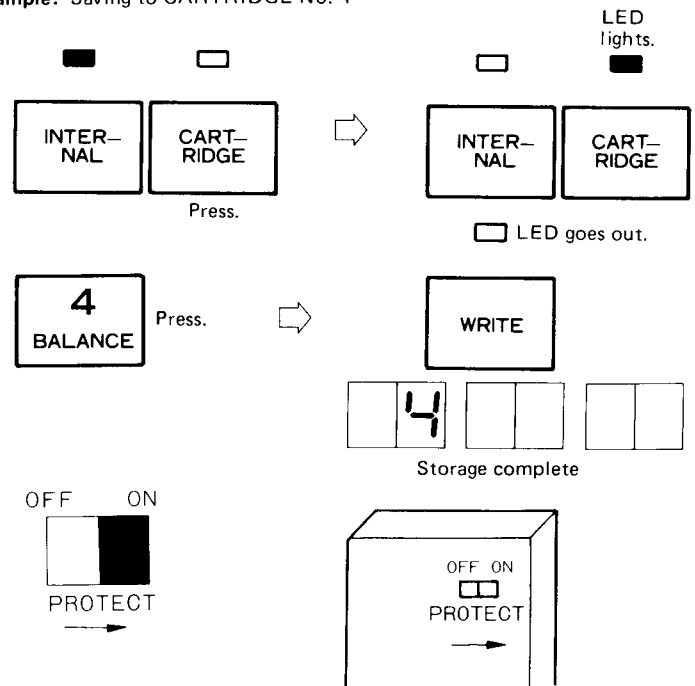

4. User-Defined Waveforms

The K-3 synthesizer comes with 32 preprogrammed sound sources – 32 built-in waveforms available for use as the fundamental building blocks for tone patches. It also provides space for additional user-defined sources. You can create and edit your own waveforms and store one in the internal memory and another one in the memory cartridge. You can also transmit this data to other equipment with MIDI system exclusive messages. (See p. 47.)

4.1 Theory

4.1.1 Pure tone

The purest sound element is a wave with a constant wavelength (pitch), a constant amplitude (loudness), and a sine shape known to scientists as a sine wave. (Light waves and AC power supplies also feature this waveform.)

4.1.2 Harmonics

The sound of a musical instrument – a piano or saxophone, for example – has a waveform that is much more complex. The amazing thing is that, at any particular instant, the waveform can be broken down and expressed as the sum of a series of sinusoidal waves whose amplitudes may differ, but whose frequencies are all whole number multiples of a single common frequency. The common frequency is called the “fundamental”; the others, the “harmonics”. In music, the second harmonic is one octave above the fundamental.

4.1.3 User-defined waveforms

A synthesizer such as the K-3 reverses the process, mixing a series of sine waves to generate complex patterns for “natural” sounds which we recognize instantly as a piano or a saxophone. In fact, all standard oscillator waveform shapes in popular synthesizers, such as triangle, sawtooth, and square waves are easy to reconstruct in this manner. Alternatively, you can choose a different set of amplitude settings and produce something totally new.

The K-3 allows you to create your own sound sources by specifying the relative intensities (amplitudes) for any 32 of the first 128 harmonics. Each intensity may be anywhere between 1 and 31. (Harmonics assigned an intensity of “0” are suppressed and do not affect the sound.)

• Pure tone

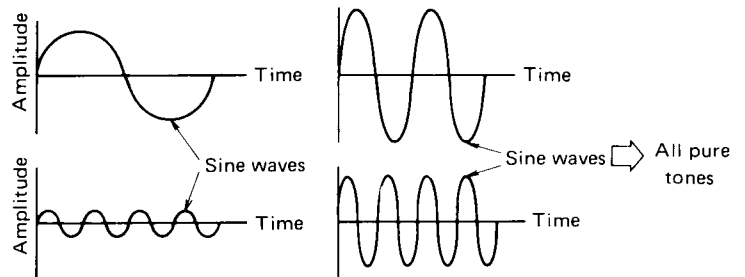

Example 1

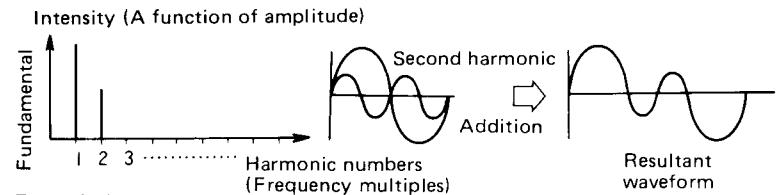

Example 2

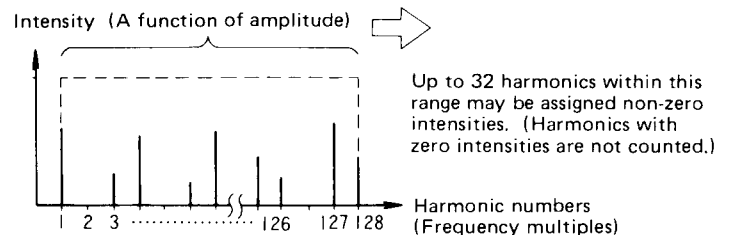
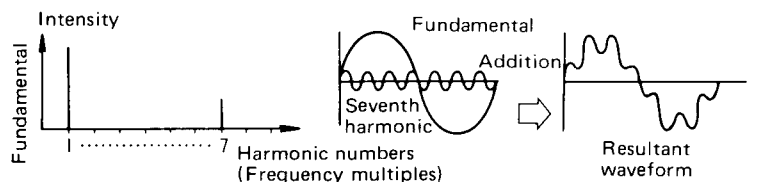

4.2 Procedure

4.2.1 Panel Controls

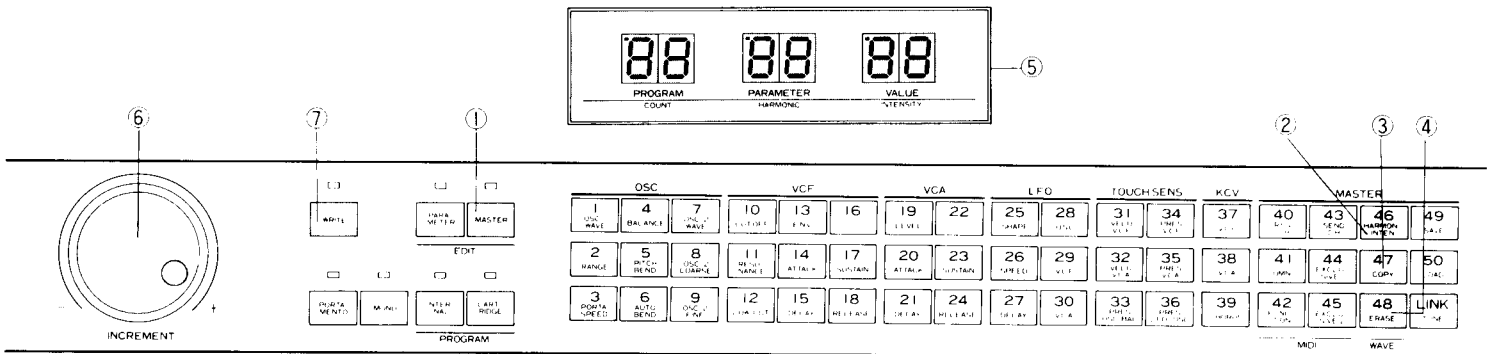

1 MASTER switch

The LED next to this switch must be on.

2 HARMON/INTEN switch

This switch is used to switch between selecting the harmonic number (1-128) and the intensity (0-31). The K-3 accepts up to 32 non-zero intensities out of the first 128 harmonics.

Value	Harmonic number
1	1
⋮	⋮
128	128

Value	Intensity
0	0
⋮	⋮
31	Maximum

3 COPY switch

This switch controls a copy function that allows you to specify a series of steadily increasing or decreasing intensities.

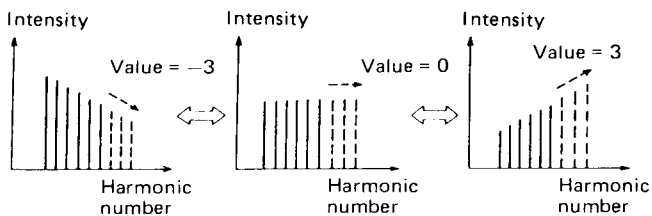

Value	Step
3	Intensity decreases by 3 for each harmonic.
⋮	⋮
0	Intensity remains the same.
⋮	⋮
3	Intensity increases by 3 for each harmonic.

4 ERASE switch

This switch reduces the intensity for the current harmonic to zero. Holding it down while turning the INCREMENT dial erases a series of harmonics.

5 Display

Pressing the MASTER switch and then the HARMON/INTEN switch changes the LED display to COUNT, HARMONIC, and INTENSITY (the lower set of labels).

6 INCREMENT knob

Turning this dial changes the HARMONIC or INTENSITY setting.

7 WRITE switch

This switch controls the playback and write functions used to test and store the edited waveform.

4.2.2 Procedure

Note: The K-3 will not let you change tone patch program location once the editing session has started. Always select the desired tone patch program location before starting to edit or create your waveform.

(1) Press the MASTER switch so that the LED next to it lights.

Note: Specifying waveform #32 (user-defined waveform) for one of the oscillators makes it easier to check the new waveform.

(2) Press the HARMON/INTEN switch to start the editing session and change the LED display to the lower set of labels:

- COUNT The number of harmonics with non-zero intensities.
- HARMONIC The number of the harmonic being edited. (initially "1").
- INTENSITY The intensity assigned to the current harmonic.

The rightmost pair of digits (INTENSITY) will flash on and off to indicate that turning the INCREMENT dial will change the intensity setting for the current harmonic.

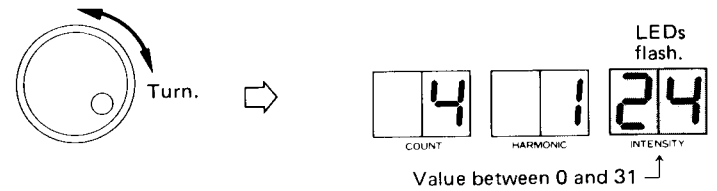
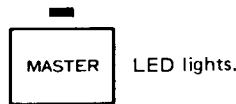

(3) Press the HARMON/INTEN switch a second time to change to the HARMONIC section of the LED display. Turning the INCREMENT dial will now change the harmonic number. The intensity assigned to that number will automatically appear in the rightmost two digits of the LED display.

(4) To change the intensity, press the HARMON/INTEN switch once again to return to step (2) and then turn the INCREMENT dial. If the intensity is zero, changing it will increase the number in the COUNT part of the LED display by 1. Conversely, lowering the intensity to zero will decrease the count by 1.

(5) Repeat steps (2)-(4) until the desired waveform is complete.

Note: The waveform is limited to a maximum of 32 harmonics.

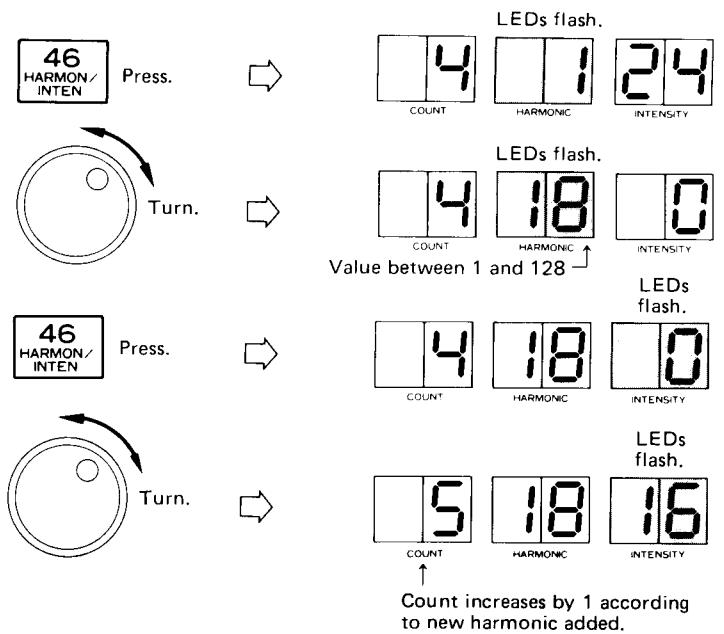

4.2.3 Checking the new waveform

While the waveform is being edited, only the original (See 4.2.5 below.) and an edited version are available. To test the edited version, you must first have the synthesizer calculate it from the new intensity specifications.

- (1) Press the WRITE switch so that the LED next to it lights. In a few seconds, the waveform will be ready to test. (The LED next to the appropriate PROGRAM switch will flash to indicate that the synthesizer is using the edited version.)
- (2) To continue editing, press the WRITE switch so that the LED goes out. The edited version of the waveform is still available for testing. (The LED next to the PROGRAM switch is still flashing.)

4.2.4 Storing the waveform

- (1) Press the WRITE switch so that the LED next to it is ON.
- (2) Press the PROGRAM switch (INTERNAL or CARTRIDGE) whose LED is flashing. (When the operation is complete, the LED next to the WRITE switch will go out, and the synthesizer will leave the editing mode. The LED next to the MASTER switch will remain lit, however.)

Note: The new waveform is stored as waveform #32 in the corresponding location: the internal memory or the removable cartridge.

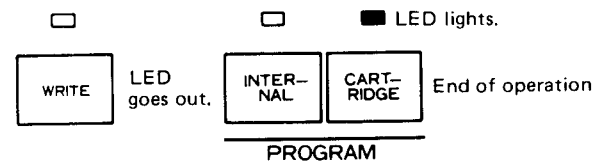
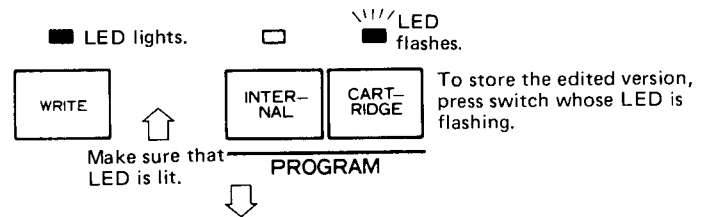
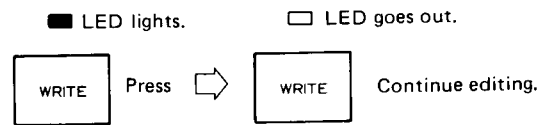
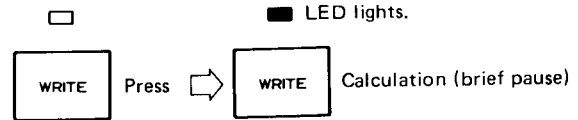

4.2.5 Comparing with the original

Until overwritten by the procedure just given (4.2.3), the original waveform is also available for comparison with the edited version.

- (1) Press the WRITE switch so that the LED next to it is OFF and the LED next to the PROGRAM switch is still flashing. It means that the edited version is available.

Note: If the LED next to the WRITE switch is lit, the next step will destroy the original version, replacing it with the edited version.

- (2) Press the appropriate PROGRAM switch. (Its LED will light to indicate that the synthesizer is using the original version.)

Note: The HARMONIC portion of the LED display will flash to indicate that you may turn the INCREMENT knob to scan the intensities stored for each harmonic. You cannot, however, press the HARMON/INTEN switch to edit them.

- (3) Press the appropriate PROGRAM switch a second time to return to the edited version. (Its LED will start flashing again.)

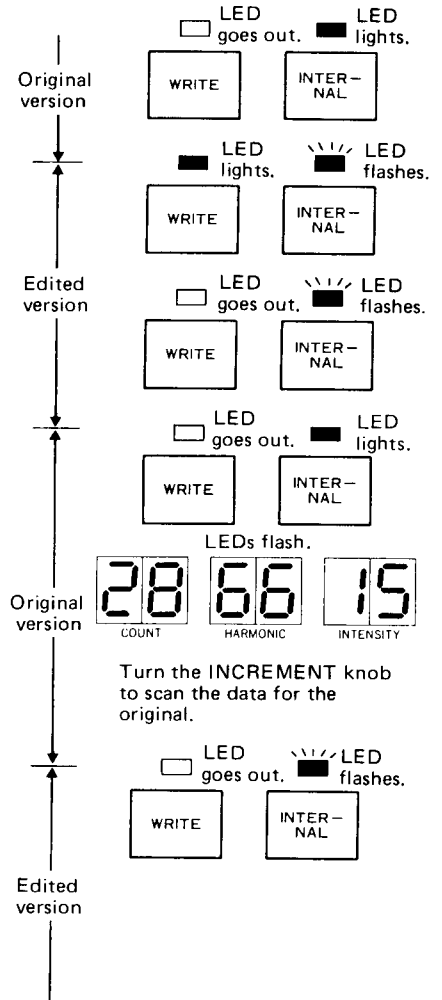
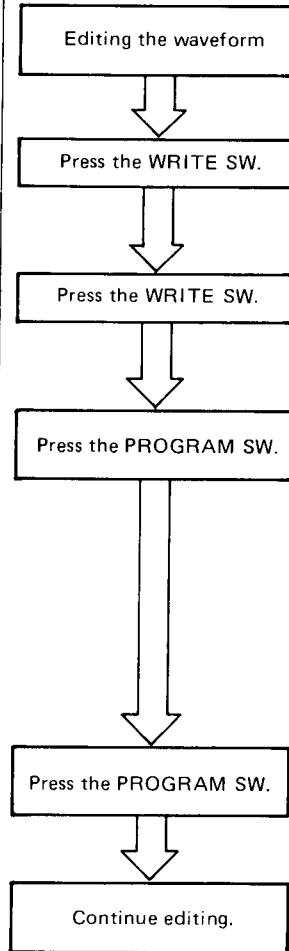

4.2.6 Additional functions

The K-3 synthesizer also features two functions designed to make editing and creating waveforms easier: the COPY and ERASE functions.

1 COPY

The COPY function is the fastest way to assign intensities to a series of harmonics so that the intensities (a) are all the same, (b) increase at a steady rate, or (c) decrease. It is available when either the HARMONIC or the INTENSITY part of the LED display is flashing.

■ Procedure

- (1) Set the intensity for the first (lowest) harmonic in the series.
- (2) Press the COPY switch to activate the function. The LED display will change to the prompt **SE EP =?** ("STEP = ?").
- (3) Turn the INCREMENT dial to select one of the seven step sizes available: 3 2 1 0 1 2 3 (-3 to 3)

- (4) Hold down the COPY switch and turn the INCREMENT dial clockwise to assign intensities to the rest of the series.

Note: The COPY function will stop functioning when the count reaches 32.

- (5) Release the COPY switch and continue editing the harmonics in the normal way.

Example

(I)

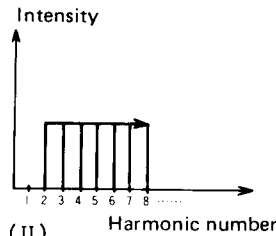

Harmonic number	1	2	3	4	5	6	7	...
Intensity	0	8	8	8	8	8	8	...

(II)

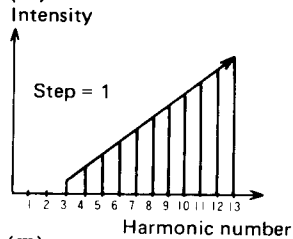

Harmonic number	3	4	5	6	7	8	...
Intensity	1	2	3	4	5	6	...

(III)

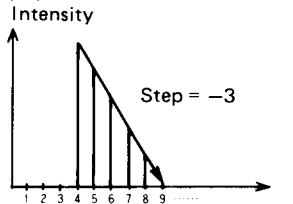

Harmonic number	4	5	6	7	8	...
Intensity	16	13	10	7	4	...

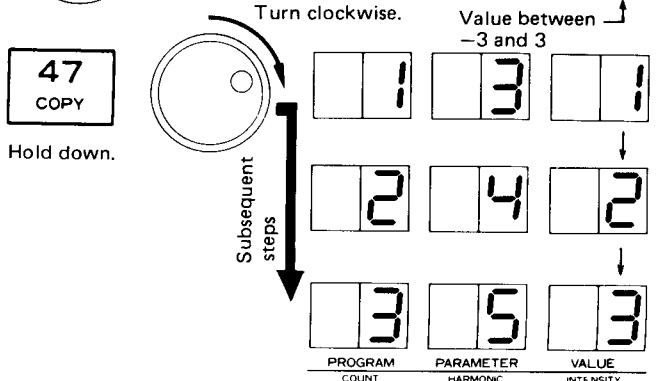
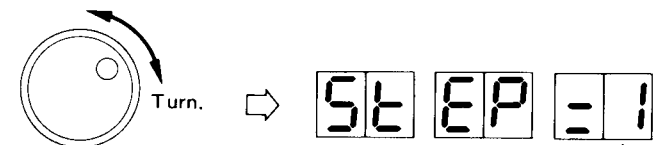
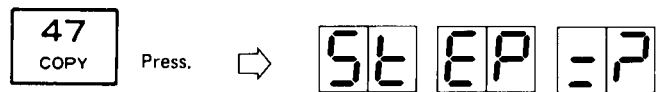

2 ERASE

The ERASE function is the fastest way to reduce the intensity of the current harmonic to zero. It may also be combined with the INCREMENT dial to clear a series of harmonics. It is available when either the HARMONIC or the INTENSITY part of the LED display is flashing.

■ Procedure

(1) Press the ERASE switch to instantly change the INTENSITY part of the LED display to zero.

(2) Hold down the ERASE switch and rotate the INCREMENT dial to clear the intensities over a range of harmonics.

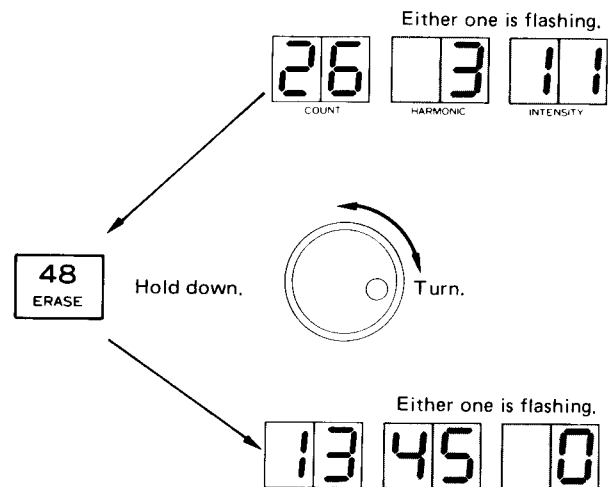
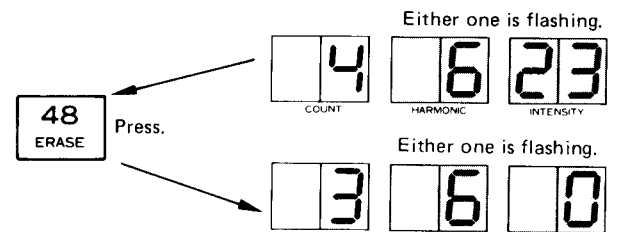

The above procedure suppresses the harmonics 3-45.

4.2.5 Sample editing session

The procedure below builds a new waveform from the harmonics shown in the graph. It assumes that all intensities have already been cleared to zero. (Use the ERASE function to do so.)

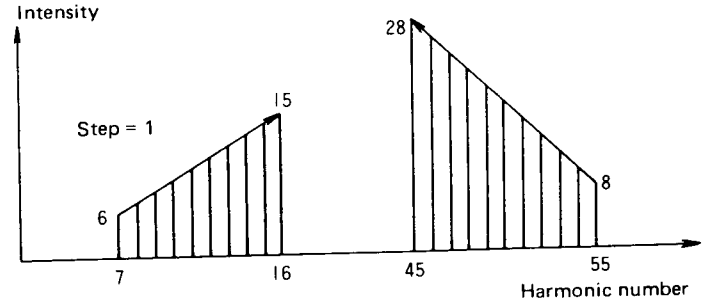

Harmonic number	7	8	9	10	11	12	13	14	15	16	—	45	46	47	48	49	50	51	52	53	54	55	...
Intensity	6	7	8	9	10	11	12	13	14	15	—	28	26	24	22	20	18	16	14	12	10	8	...

■ Procedure

- (1) Press the MASTER switch so that the LED next to it lights.
- (2) Press the HARMON/INTEN switch so that the INTENSITY part of the LED display flashes.
- (3) Press the HARMON/INTEN switch to change to the HARMONIC part of the LED display.
- (4) Turn the INCREMENT dial until the LED display reads "7".
- (5) Press the HARMON/INTEN switch to change to the INTENSITY part of the LED display.
- (6) Turn the INCREMENT dial until the LED display reads "6".
- (7) Press the COPY switch to activate the COPY function.

SE EP = 7

■ LED lights.

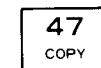
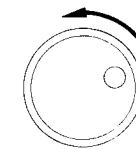
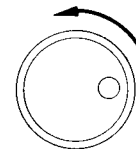

Press.

Press.

Turn.

Press.

Turn.

Press.

LEDs flash.

LEDs flash.

LEDs flash.

LEDs flash.

LEDs flash.

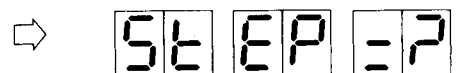
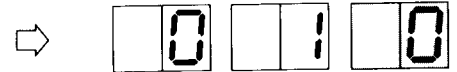

(8) Turn the INCREMENT dial until the LED display reads "1".



(9) Hold down the COPY switch and turn the INCREMENT dial clockwise until the HARMONIC part of the LED display reads "16".

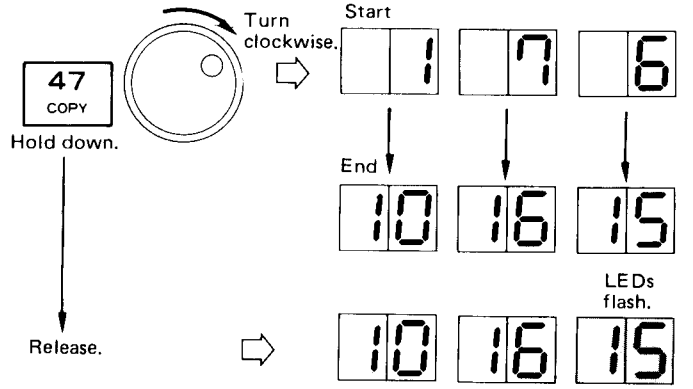

(10) Press the HARMON/INTEN switch to change to the HARMONIC part of the LED display.

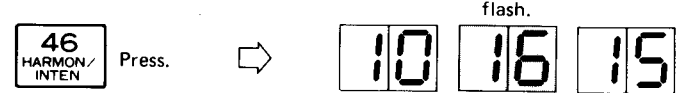

(11) Turn the INCREMENT dial until the LED display reads "55".

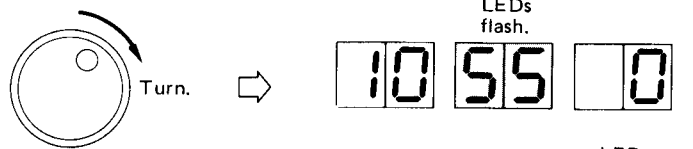

(12) Press the HARMON/INTEN switch to change to the INTENSITY part of the LED display.

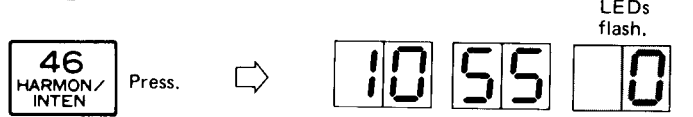

(13) Turn the INCREMENT dial until the LED display reads "8".

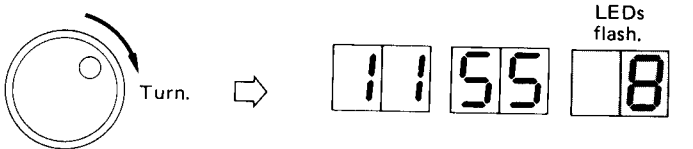

(14) Press the COPY switch to activate the COPY function.



(15) Turn the INCREMENT dial until the LED display reads "2".



- (16) Hold down the COPY switch and turn the INCREMENT dial counterclockwise until the HARMONIC part of the LED display reads "45".

Note: The step size is independent of the direction of dial rotation. This example uses a positive step size and counterclockwise rotation to produce a steadily decreasing series. The same series could also be produced with a negative step size and clockwise rotation.

- (17) Press the WRITE switch to light the LED next to it and then wait a couple of seconds while the synthesizer makes the necessary calculations.

- (18) If satisfied with the resultant waveform, store it by pressing the PROGRAM switch (INTERNAL or CARTRIDGE) whose LED is flashing. Otherwise, press the WRITE switch so that the LED next to it goes out and continue editing.

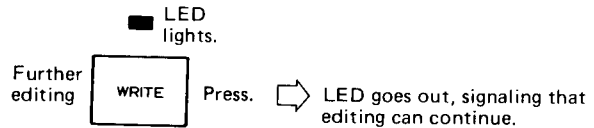
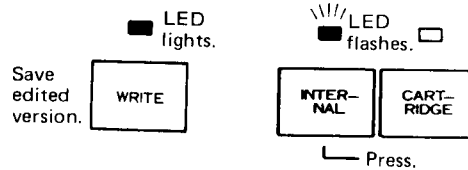
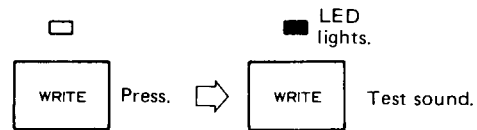
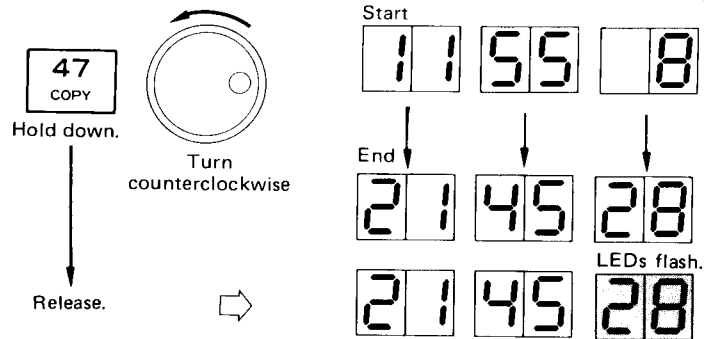

5. Performance Functions

This section describes the K-3 features especially useful for live performance.

5.1 LINK

5.1.1 Description

This function allows you to link together, in advance, a sequence of up to 31 tone patch programs into a chain. Then, in the middle of a performance, all that is needed to step through the chain is a single touch of the LINK switch.

5.1.2 Using the function

(1) Make sure that the synthesizer is in the program mode – that is, that only a PROGRAM LED (INTERNAL or CARTRIDGE) is lit.

- (2) Press the LINK switch to change to the first tone patch of the sequence. A dot will appear to the upper left of the program number on the LED display to indicate that the synthesizer is using a patch from a chain.
- (3) When it is time to change to the next number of the chain, press the LINK switch.

Notes:

- (1) The chain may freely mix tone patches from both the internal memory and the removable memory cartridge.
- (2) The chain is an endless loop. At the end of the chain, pressing the LINK switch changes the tone patch from the last to the first.
- (3) To break out of the loop, simply change tone patches manually.
- (4) Pressing the LINK switch to reenter the loop automatically restarts the sequence from the first tone patch.
- (5) A foot switch plugged into the PROGRAM UP jack on the synthesizer's rear panel provides the same linking function.

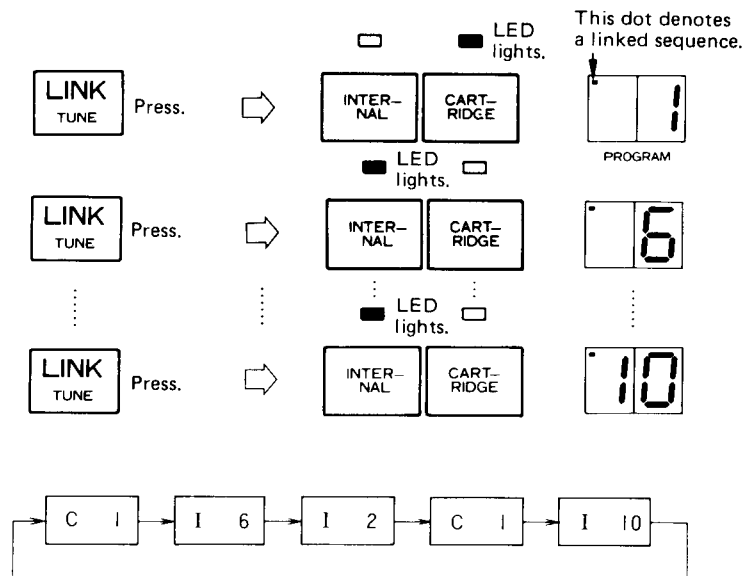
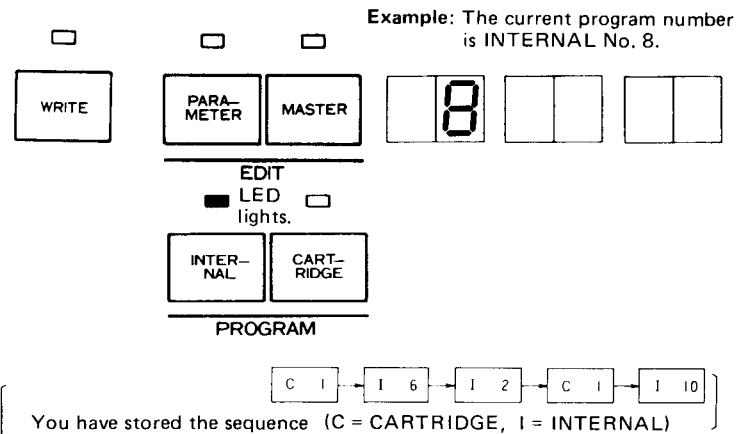

5.1.3 Storing a chain

(1) Press the WRITE switch so that the LED next to it lights.

(2) Press the LINK switch. The PROGRAM part of the LED display will flash to indicate that the synthesizer is waiting for input.

Note: If no selection has been made, pressing the WRITE switch a second time turns off the LED and cancels the storage operation.

(3) Press the switch combinations for the desired sequence of tone patches. (Remember that it is always possible to change banks by pressing INTERNAL or CARTRIDGE before pressing a number selector.) Pressing the first such combination will change the PROGRAM part of the LED display to the selected program number and a dot. It will also destroy any previously recorded sequence.

(4) When the series is complete, press the WRITE or LINK switch to turn off the LED next to the WRITE switch.

Note: Up to 31 program numbers can be stored in a link.

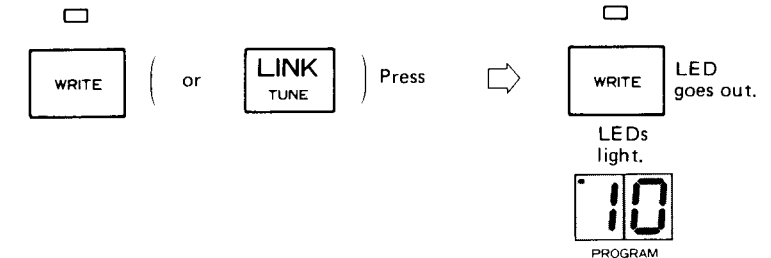
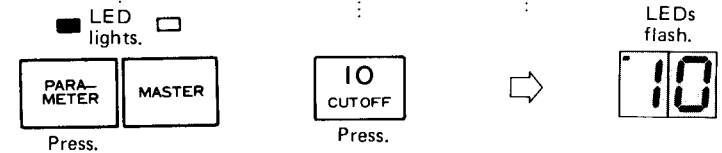
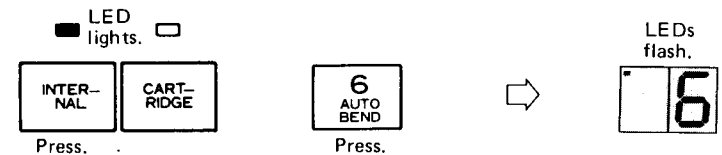
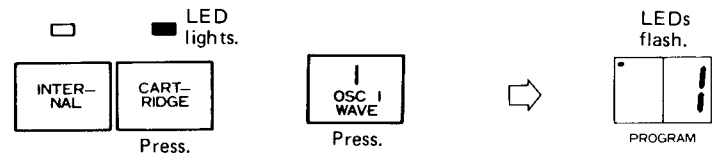
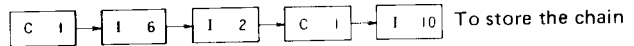
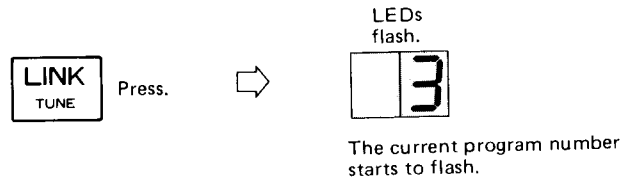
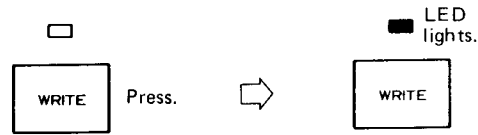

5.2 TUNE

This function allows you to adjust the pitch of the K3 to match another instrument.

■ Procedure

(1) Press the MASTER switch so that the LED next to it lights.

(2) Press the LINK/TUNE switch.

(3) Turn the INCREMENT dial to adjust the pitch.

Note: This setting remains in effect even after the power is turned off.

Value	Tuning
50	Lower
}	}
0	A3 = 440 Hz
}	}
50	Higher

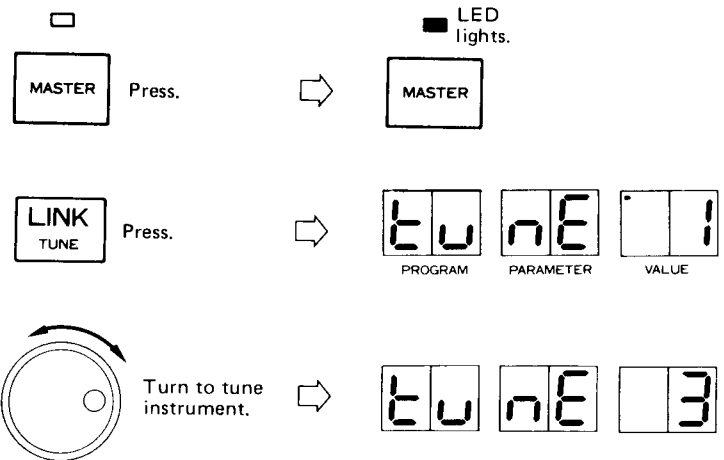

5.3 PITCH BEND Wheel

Pushing or pulling the PITCH BEND wheel will "slide" the pitch of the selected tone patch to create effects similar to bending a guitar string or sliding a trombone note. Pushing the wheel forward (away from you) raises the pitch, pulling it backward (towards you) lowers the pitch. The maximum possible pitch bend effect is 5 half steps (or notes). You can pre-set the pitch bend amount using parameter #5. (See p. 10.).

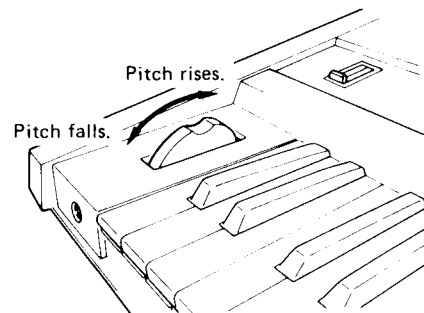

5.4 INCREMENT Dial

The K-3's editing parameters are always available at the touch of a button. The K-3 lets you change the value of a parameter even during a performance simply by rotating the INCREMENT dial. To set a particular parameter for live editing, simply assign it to the tone patch program just before you "lock in" the tone patch to memory. When you turn the INCREMENT dial (no need to press Parameter) you will automatically be adjusting the last parameter you set.

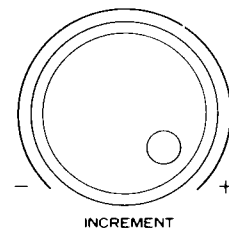

5.5 PORTAMENTO Switch

Activating this switch provides a "portamento" or a "gliding" effect. The speed of this glide is determined by parameter #3 (PORTA SPEED). (See p. 10.) This switch setting is also stored with the tone patch data.

5.6 MONO Switch

Activating this switch "stacks" the oscillators to provide a very fat "lead synthesizer" sound. This switch setting is also stored with the tone patch data.

5.7 RELEASE Pedal

A grounded "normally closed" foot switch connected to the RELEASE jack on the rear panel of the synthesizer produces an effect similar to that of the damper pedal on a piano. Pressing the pedal (and opening the switch) extends the envelope's release time to the maximum possible.

5.8 PROGRAM UP Pedal

A grounded foot switch connected to the PROGRAM UP jack on the rear panel of the synthesizer allows you to change tone patches by pressing the pedal. The next tone patch used depends on whether the LINK function is activated – in other words, on whether there is a dot in the PROGRAM part of the LED display:

- (1) If the dot is present, the synthesizer follows the order specified in a preprogrammed linked series. The pedal therefore duplicates the function of the LINK switch.
- (2) If there is no dot, pressing the switch changes the tone patch to the next one in the internal memory or removable memory cartridge.

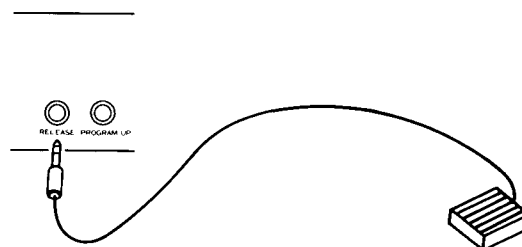
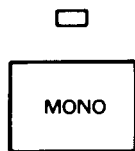

5.9 VELOCITY SENS (Initial touch)

A custom LSI in the K-3 allows you to use the speed with which you strike the keys to vary tone patch sound and volume.

■ Tone patch

Increasing the velocity amount routed to the filter produces a brighter sound. (See parameter #31, VELO VCF, on p. 19.)

■ Volume

Increasing the velocity amount routed to the loudness circuit produces a higher output level. (See parameter #32, VELO VCA, on p. 19.)

5.10 PRESSURE SENS (Aftertouch)

The K-3 allows you to use aftertouch (continued pressure after striking) to regulate even more effects.

■ Mixing balance

Increasing the pressure shifts the mixing balance in favor of oscillator No. 2. (See parameter #33, PRES OSC BAL, on p. 20.)

■ Tone patch

Increasing the pressure produces a brighter sound. (See parameter #34, PRES VCF, on p. 21.)

■ Volume

Increasing the pressure produces a higher output level. (See parameter #35, PRES VCA, on p. 21.)

■ Vibrato

Increasing the pressure adds more vibrato or LFO effect (See parameter #36, PRES LFO-OSC, on p. 22.)

6. Saving and Loading Data

The K-3 synthesizer uses removable random-access memory (RAM) cartridges for external storage because they provide fast data transfers. Each cartridge holds 50 programs and the harmonic/intensity data for one user-defined waveform. Additional cartridges are available at a reasonable cost for holding additions to your library of sounds and for making backup copies of the data in the synthesizer's internal memory. To order, contact your local Kawai dealer.

6.1 SAVE

6.1.1 Definition

The save operation copies data from the synthesizer's internal memory to the memory cartridge currently in the slot. In the process, it also destroys the previous contents of the cartridge, so always make sure that the cartridge does not contain valuable data. Also make sure that the cartridge is firmly in place in the slot.

6.1.2 Procedure

- (1) Press the MASTER switch so that the LED next to it lights. It does not matter which PROGRAM (INTERNAL or CARTRIDGE) LED is lit.
- (2) Shift the PROTECT switch on the cartridge to the OFF position. If the switch is in its ON position, any attempt to write new data to the cartridge will abort, producing the message `Pr ot ct` ("Protect") on the LED display.
- (3) Press the SAVE switch.
- (4) When the operation is complete (in less than one second), return the PROTECT switch on the cartridge to its ON position to protect the contents from accidental erasure.

Note: At the end of the operation, the PROGRAM part of the LED display will change to "1".

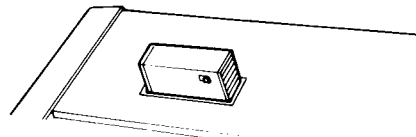
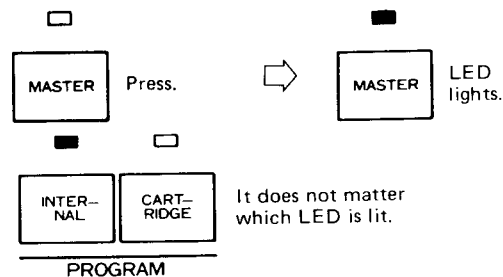
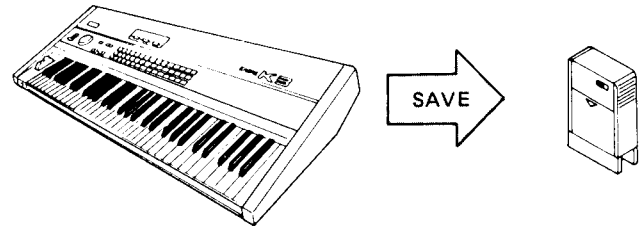

6.2 LOAD

6.2.1 Definition

The load operation copies data to the synthesizer's internal memory from a memory cartridge. It also erases the previous contents of the internal memory, so you may wish to save them to another cartridge first.

6.2.2 Procedure

- (1) Press the MASTER switch so that the LED next to it lights. It does not matter which PROGRAM (INTERNAL or CARTRIDGE) LED is lit.

- (2) Shift the PROTECT switch on the synthesizer's rear panel to the OFF position. If the switch is in its ON position, any attempt to write new data to the internal memory will abort, producing the message **Pr ot ct** ("Protect") on the LED display.

- (3) Press the LOAD switch.

- (4) When the operation is complete (in less than one second), return the PROTECT switch on the synthesizer's rear panel to its ON position to protect the contents from accidental erasure.

Note: At the end of the operation, the PROGRAM part of the LED display will change to "1".

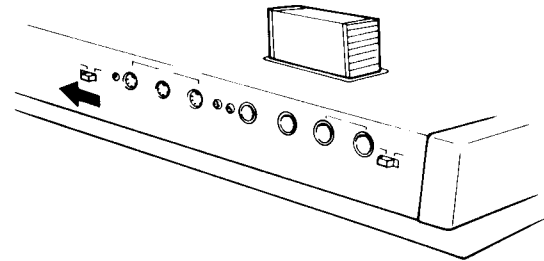
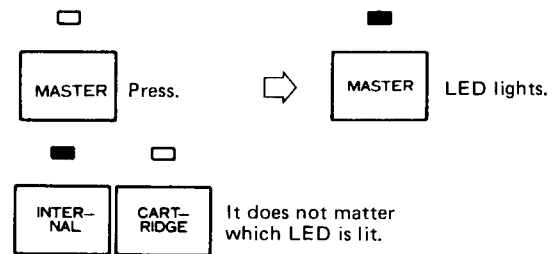
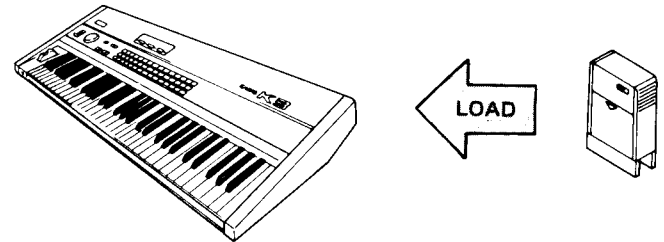

7. MIDI Interface

The letters MIDI stand for Musical Instrument Digital Interface, an international standard for connecting drum machines, synthesizers, other electrical/electronic musical instruments, and personal computers so that they can communicate intelligently.

All such equipment with this interface can be interconnected with standard MIDI – no matter who the individual manufacturers may be, however MIDI implementation may vary from manufacturer to manufacturer.

7.1 Typical Connections

7.1.1 The master keyboard approach

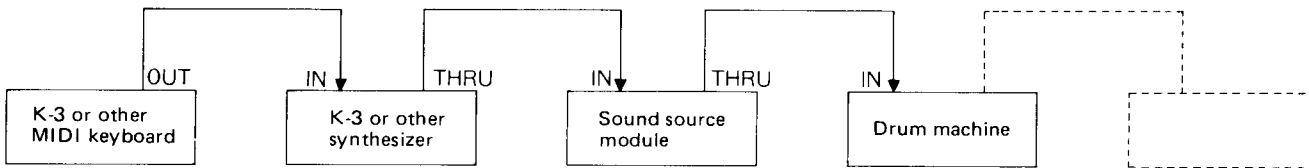

This type of arrangement enables you to play a variety of instruments – either singly or in ensemble – from a single keyboard.

7.1.2 Automatic operation with a MIDI sequencer

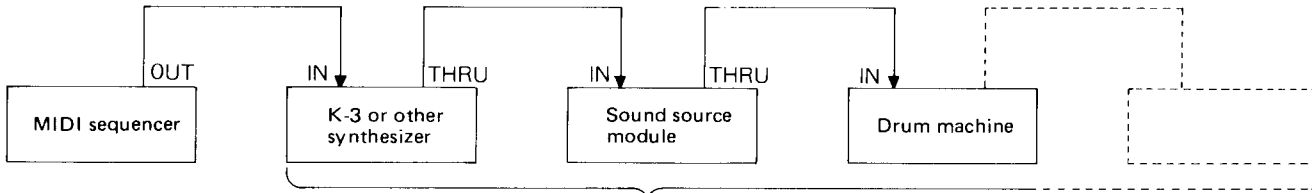

These instruments may be assigned separate channels so that they play separate parts.

7.1.3 Connection to a personal computer

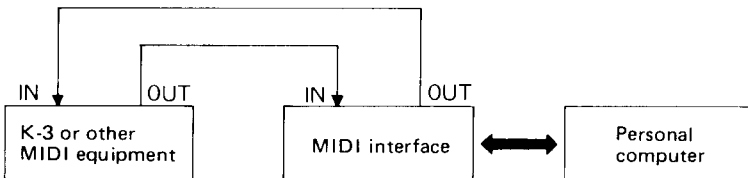

With this arrangement, you can use software to program tone patches or set up tone patch selection sequences for MIDI-equipped instruments. Contact your local Kawai dealer for information regarding availability of K-3 software for your personal computer.

7.2 The K-3 MIDI Implementation

7.2.1 Signals

The K-3 synthesizer is capable of sending and receiving the following types of MIDI signals or "messages".

Message	Meaning	Send	Receive
■ NOTE OFF	Indicates the release of a key.	○	○
■ NOTE ON	Includes the pitch and velocity of the key struck.	○	○
■ MODULATION	Modulation		○
■ VOLUME	Controls output level.		○
■ PORTAMENTO TIME	Determines the speed of the portamento effect.	○	○
■ DAMPER PEDAL SWITCH	Indicates the status (ON/OFF) of the damper (release) pedal.	○	○
■ PORTAMENTO SWITCH	Turns the portamento effect on and off.	○	○
■ PROGRAM CHANGE	Includes the number of the next program to be used.	○	○
■ CHANNEL PRESSURE	Describes the aftertouch.	○	○
■ PITCH BENDER CHANGE	Rotates the receiving instrument's pitch bender wheel.	○	○
■ ALL NOTE OFF	Turns off all current output.	○	○
■ OMNI MODE OFF	Directs the receiving instrument(s) to accept only data on the assigned MIDI channel.		○
■ OMNI MODE ON	Directs the receiving instrument(s) to accept data on all MIDI channels.		○
■ ACTIVE SENSING	Checks for disconnection.	○	○
■ SYSTEM EXCLUSIVE MESSAGES	Send and receive tone patch and waveform data.	○	○

Note numbers

The MIDI standard assigns note numbers to each note on the keyboard. The K-3's 5-octave keyboard covers notes 36-96.

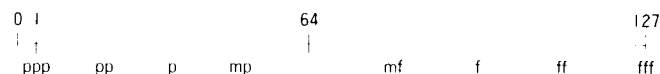
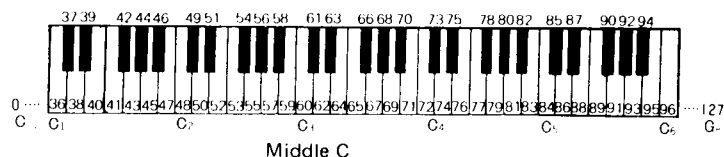

Key velocity

This term refers to the initial touch, the force with which you strike the key. The key velocity determines the note's volume or tone patch. The K-3 quantifies velocity according to the scale shown.

Program change

The K-3 uses different sets of program numbers for the tone patches stored in the internal memory and removable memory cartridge and converts between its system and the MIDI system using the scheme outlined in the accompanying chart.

K-3 INTERNAL	1	2	3	4	50
MIDI program number	0	1	2	3	49
K-3 CARTRIDGE	1	2	3	4	50
MIDI program number	50	51	52	53	99

Send : 0~99
Receive : 0~127

Note: All out-of-range numbers received (100~127) are interpreted as 1 (11).

7.2.2 Panel Controls

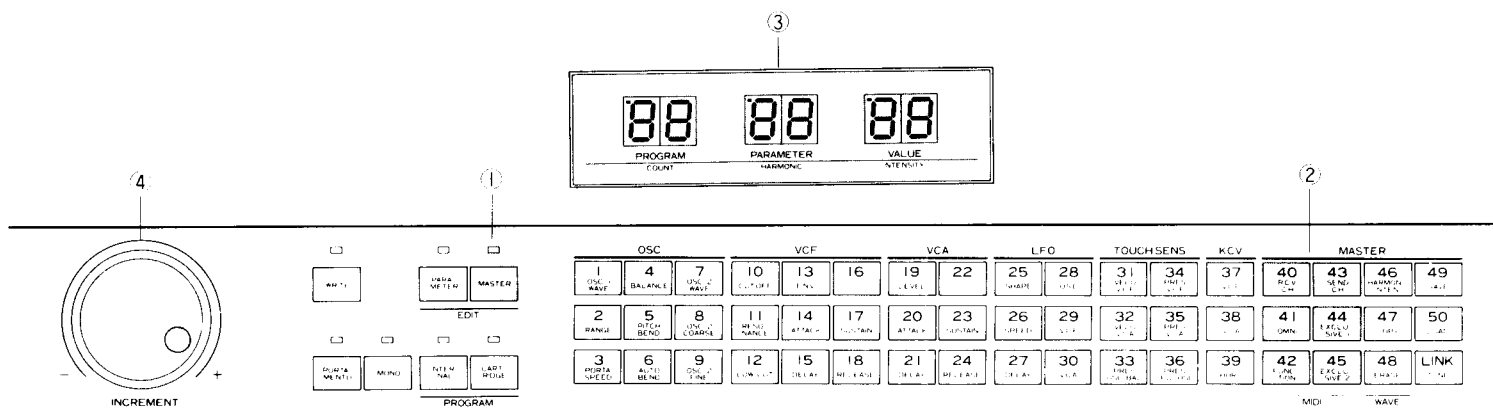

1 MASTER switch

This switch controls access to the MIDI interface controls.

2 MIDI parameter switches

These six switches (RCV CH, OMNI, FUNCTION, SEND CH, EXCLUSIVE I, and EXCLUSIVE II) control the MIDI interface parameters.

3 Display

This uses the same set of labels as the edit function: PROGRAM number, (MIDI) PARAMETER number, and VALUE.

4 INCREMENT dial

Turning this dial changes the value of the current MIDI parameter.

7.2.3 Description of parameters and their values

#40. RCV CH (RECEIVE Channel) (1 to 16)

This parameter determines the only MIDI channel on which the K-3 synthesizer will receive when parameter #41, OMNI, is OFF.

The value you select will remain unchanged even after the power is turned off.

#41. OMNI (0/1)

This parameter switches the OMNI function ON and OFF. If it is ON, the synthesizer will act on all MIDI messages on all MIDI channels. Otherwise, it will accept only those messages received on the channel specified with parameter #40, RCV CH.

The value of this parameter may change in response to OMNI ON and OMNI OFF messages received through the MIDI interface. The value will remain unchanged even after the power is turned off.

Value	Receive channel
1	Channel 1
16	Channel 16

Value	OMNI mode
0	OFF
1	ON

#42. FUNCTION (1 to 6)

This parameter determines on what level the synthesizer will respond to incoming messages. The higher the number, the greater the variety of data it will accept. (See chart.) The value will remain unchanged even after the power is turned off.

Value	Data accepted
1	Note numbers (no velocity) + Damper + Active sensing
2	Above + Velocity
3	Above + Pressure + Pitch bender + Modulation
4	Above + Program change
5	Above + Portamento + Volume
6	Above + System exclusive messages

#43. SEND CH (SEND Channel) (1 to 16)

This parameter determines the MIDI channel on which the K-3 synthesizer will send MIDI messages. The value will remain unchanged even after the power is turned off.

Value	Send channel
1	Channel 1
16	Channel 16

#44. EXCLUSIVE I (0/1)

This parameter allows you to send tone patch data using MIDI "system exclusive" messages. It always starts at "0" (OFF) when the power is first applied.

Value	Tone data transmission
0	OFF
1	ON

■ Procedure

- Press the MASTER switch so that the LED next to it lights.
- Turn the INCREMENT dial until the PARAMETER part of the LED display reads "1".
- Press the MASTER switch a second time so that the LED next to it goes out.
- Press the switch combination for a tone patch – CARTRIDGE No.3, for example.

The above procedure sends the tone patch data to the receiver. If you later edit that data, the synthesizer will automatically send the amended version.

- To stop sending, press the MASTER switch so that the LED next to it lights and change the PARAMETER part of the LED display to "0".

Notes:

- The sender and the receiver must be connected to the same MIDI channel.
- The PROTECT switch at the receiving end must be in its OFF position.
- For the messages to have any effect, the receiver must have the highest value (6) for parameter #42 FUNCTION.

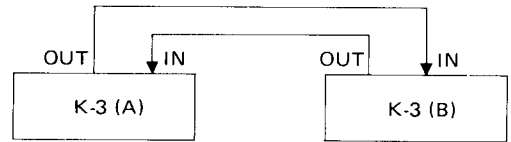

Example: Exchanging tone patch data between K-3's

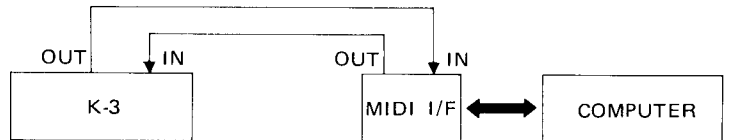

Example: Sending K-3 tone patch data to a personal computer for editing

#45. EXCLUSIVE II (0/1)

This parameter allows you to send user-defined waveform data using MIDI "system exclusive" messages. It always starts at "0" (OFF) when the power is first applied.

■ **Procedure**

- (1) Press the PROGRAM switch (INTERNAL or CARTRIDGE) corresponding to the waveform to be sent.
- (2) Press the MASTER switch so that the LED next to it lights.
- (3) Turn the INCREMENT dial until the PARAMETER part of the LED display reads "1".
- (4) Press the PROGRAM switch a second time.

The above procedure sends the specified user-defined waveform data to the receiver. The PARAMETER part of the LED display automatically returns to "0".

Value	Waveform data transmission
0	OFF
1	ON

1. TRANSMITTED DATA

Status	2nd	3rd	Description
1001nnnn	0kkkkkkk	00000000	Note off kkkkkkk 36-96
1001nnnn	0kkkkkkk	0vvvvvvv	Note on kkkkkkk=36-96 vvvvvvv=1-127
1011nnnn	00000101	0vvvvvvv	Portamento Time vvvvvvv 0-127
1011nnnn	01000000	00000000 01111111	Release off Release on
1011nnnn	01000001	00000000 01111111	Portamento off Portamento on
1100nnnn	0pppppppp		Program Change pppppppp 0-99 (After Touch)
1101nnnn	0vvvvvvv		Channel Pressure (After Touch) vvvvvvv 0-127
1110nnnn	0v000000	0vvvvvvv	Pitch Bender Change vvvvvvvv=0-255
1011nnnn	01111011	00000000	All Note off
11111110			Active Sensing

2. RECOGNIZED RECEIVE DATA

Status	2nd	3rd	Description
1000nnnn	0kkkkkkk	0xxxxxxx	Note off kkkkkkk 0-127 (21-108) xxxxxxx Ignored
1001nnnn	0kkkkkkk	0vvvvvvv	Note on off kkkkkkk 0-127 (21-108) vvvvvvv 0 Note off vvvvvvv 1-127 Note on
1011nnnn	00000001	0vvvvvvv	Modulation vvvvvvv 0-127
1011nnnn	00000101	0vvvvvvv	Portamento time vvvvvvv 0-127
1011nnnn	00000111	0vvvvvvv	Volume vvvvvvv 0-127
1011nnnn	01000000	0vvvvvvv	Release vvvvvvv 0-63 off vvvvvvv 64-127 on
1011nnnn	01000001	0vvvvvvv	Portamento SW vvvvvvv 0-63 off vvvvvvv 64-127 on
1100nnnn	0pppppppp		Program Change pppppppp 0-49 (internal 1-50) pppppppp 50-99 (cartridge 1-50) pppppppp 100-127 (internal 1)
1101nnnn	0vvvvvvv		Channel Pressure (After Touch) vvvvvvv 0-127
1110nnnn	0v000000	0vvvvvvv	Pitch Bender Change vvvvvvv 0-255
1011nnnn	01111011	00000000	All Notes off
1011nnnn	01111100	00000000	Omni off
1011nnnn	01111101	00000000	Omni on
1011nnnn	01111111	00000000	Poly on
11111110			Active Sensing

3. EXCLUSIVE

3-1 EXCLUSIVE FORMAT

3-1-1 K3 EXCLUSIVE FORMAT 1 (General)

No	Byte	Description
1	11110000	System Exclusive
2	01000000	KAWAI ID No
3	0000cccc	Channel No cccc 0-15
4	0ffffff	Function No ffffff 0-97
5	00000000	Group No
6	00000001	K3 ID No
7	0ttttttt	Data
11	11111110	End of System Exclusive

3-1-2 K3 EXCLUSIVE FORMAT 2 (Machine ID Request)

No	Byte	Description
1	11110000	System Exclusive
2	01000000	KAWAI ID No
3	0000cccc	0-15 CH. No
4	01100000	Function No (Machine ID Request)
5	11111110	End of System Exclusive

3-2 K3 DATA FORMAT

3-2-1 DATA FORMAT 1 (REQUEST)

No	Byte	Description
7	0ttttttt	0-101 Sub Command

3-2-2 DATA FORMAT 2 (PARAMETER SEND)

No	Byte	Description
7	0ttttttt	1-39 Sub Command (Parameter No.)
8	0000tttt	0-31 Date High Nibble. See 3-3
9	0000tttt	0-31 Date Low Nibble

Trans as follow

No	Exclusive Data	TONE DATA
8	0000abcd	abcd
9	0000efgh	efgh

3-2-3 DATA FORMAT 3 (DUMP)

No	Byte	Description
7	0ttttttt	0-102 Sub command
8	0000dddd	0-31 = 1 Data High Nibble. See 3-3-3-4
9	0000dddd	0-31 = 1 Data Low Nibble
10	0000dddd	0-31 = 2 Data High Nibble
11	0000dddd	0-31 = 2 Data Low Nibble

Trans as follow

No	Byte	TONE or WAVE DATA
n	0000abcd	abcd
n-1	0000efgh	efgh
n+2	0000ijkl	ijkl
n+3	0000mnop	mnop

3-2-4 DATA FORMAT 4 (others)

No Data Needs

3-3 K3 TONE DATA

#	Data	Parameter No	Description
1	aaccccc	2	aa0 16 1 8 2 4
		1	cccccc 0 33 OSC1 Wave Select
2	accccccc	a	Portamento Sw
		3	cccccc 0 99 Portamento Speed
3	xxxxtttt	7	0 33 OSC2 Wave Select
4	txxttttt	8	0 24 OSC2 Coarse
5	txxttttt	9	0 10 OSC2 Fine
6	txxttttt	4	0 15 Balance
7	txxttttt	6	0 31 Auto Bend
8	axxxxxcc	5	a Mono Sw ccc 1 7 Pitch Bend
9	xttttttt	10	0 99 VCF Cutoff
10	xxxttttt	11	0 31 VCF Resonance
11	xxxttttt	13	0 31 VCF Env
12	xxxttttt	14	0 31 VCF Attack
13	xxxttttt	15	0 31 VCF Decay
14	xxxttttt	12	0 31 Low Cut
15	xxxttttt	17	0 31 VCF Sustain
16	xxxttttt	18	0 31 VCF Release
17	xxxttttt	19	0 31 VCA Level
18	xxxttttt	20	0 31 VCA Attack
19	xxxttttt	21	0 31 VCA Decay
20	xxxttttt	23	0 31 VCA Sustain
21	xxxttttt	24	0 31 VCA Release
22	xxxxtttt	25	1 7 LFO Shape
23	xttttttt	26	0 99 LFO Speed
24	xxxttttt	27	0 31 LFO Delay
25	xxxttttt	28	0 31 LFO OSC
26	xxxttttt	29	0 31 LFO VCF
27	xxxttttt	30	0 31 LFO VCA
28	aaaacccc	32	aaaa 0 15 Velocity VCA
		31	cccc 0 15 Velocity VCF
29	aaaacccc	34	aaaa 0 15 Pressure VCF
		33	cccc 0 15 Pressure OSC Balance
30	aaaacccc	36	aaaa 0 15 Pressure LFO-OSC
		35	cccc 0 15 Pressure VCA
31	txxttttt	37	0 15 KCV VCF
32	txxttttt	38	0 15 KCV VCA
33	xxxxtttt	39	0 7 Chorus
34	xttttttt	0	39 No. of Parameter Assigned to Increment Knob
35	tttttttt	0	255 Check Sum, Sum of Value No. 1 to No. 34

3-4 K3 WAVE DATA

#	Data	Description
1	tttttttt	1 128 Harmonics No
2	xxxttttt	1 31 Intensity
3	tttttttt	1 128 Harmonics No
4	xxxttttt	1 31 Intensity
	tttttttt	1 128 Harmonics No
	xxxttttt	1 31 Intensity
	00000000	0 End Mark
	xxxxxxx	ignored
64	xxxxxxx	
65	tttttttt	0 255 Check Sum, Sum of Value No. 1 to No. 64

3-5 K3 MIDI EXCLUSIVE FUNCTION TABLE

Function	Function No.	Sub Command	Description	TRS*	RCV
One Block Data Request	0	0 - 49	Internal Tone 1 - 50 Data Request	*	
	0	50 - 99	Cartridge Tone 1 - 50 Data Request	*	
	0	100	Internal User Wave Data Request	*	
	0	101	Cartridge User Wave Data Request	*	
All Block Data Request	1	0	Internal All Tone Data Request	*	
	1	1	Cartridge All Tone Data Request	*	
Parameter Send	16	1 - 39	Parameter Value Send 1-39= Parameter No.		
One Block Data Dump	32	0 - 49	Internal Tone 1 - 50 Data Dump		
	32	50 - 99	Cartridge Tone 1 - 50 Data Dump		
	32	100	Internal User Wave Data Dump		
	32	101	Cartridge User Wave Data Dump		
	32	102	MIDI WAVE DUMP		
All Block Data Dump	33	0	Internal All Tone Data Dump	*	
	33	1	Cartridge All Tone Data Dump	*	
Write Complete	64	-			
Write Error	65	-			
Write Error by Protect	66	-			
Write Error by No Cartridge	67	-			
Machine ID Request	96	-			
Machine ID Acknowledge	97	-			

* Trns only when parameter "EXCLUSIVE I"=1

* Rcv only when parameter "FUNCTION"=6

8. Specifications

Keyboard		61 keys (five octaves, C-C) with initial touch and aftertouch	
Sound sources		Six voices	
Program capacity		INTERNAL/ CARTRIDGE	50 programs each – with LINK function
EDIT	PARAMETER	OSC	OSC 1 WAVE, OSC 2 WAVE, OSC 2 COARSE, OSC 2 FINE RANGE, BALANCE, PITCH BEND, AUTO BEND, PORTA SPEED
		VCF	CUTOFF, RESONANCE, ENV, ATTACK, DECAY, SUSTAIN, RELEASE, LOW CUT
		VCA	LEVEL, ATTACK, DECAY, SUSTAIN, RELEASE
		LFO	SHAPE, SPEED, DELAY, OSC, VCF, VCA
		TOUCH SENS	VELO VCF, VELO VCA, PRES OSC BAL, PRES VCF, PRES VCA, PRES LFO-OSC
		KCV	VCF, VCA
		CHORUS	CHORUS/TREMOLO/DELAY
	MASTER	MIDI	RCV CH, OMNI, FUNCTION, SEND CH, EXCLUSIVE I, EXCLUSIVE II
		WAVE	HARMON/INTEN, COPY, ERASE
		CARTRIDGE I/F	SAVE, LOAD
MASTER TUNE		TUNE	
Function switches		WRITE, PORTAMENTO, and MONO	
Controls		PITCH BEND wheel, INCREMENT dial, and VOLUME control	
Memory cartridge		Memory cartridge (with switch) and cartridge slot	
Wood-finish front panel		Headphone jack	
Rear panel		Output jacks (L/MONO, R), Output level switch (H/L), PROGRAM UP jack, RELEASE jack, PROTECT switch, MIDI connectors (IN, OUT, and THRU), and POWER switch	
Display		Three 2-digit LED displays (PROGRAM/COUNT, PARAMETER/HARMONIC, and VALUE/INTENSITY)	
Dimensions		964 (W) x 373 (D) x 118 (H) mm	
Weight		15 kg	
Power consumption		38 W	

MODEL KAWAI K3 MIDI Implementation Chart

Function		Transmitted	Recognized	Remarks
Basic Channel	Default	1-16	1-16	Memorized
	Changed	1-16	1-16	
Mode	Default		1.3	Memorized
	Messages Altered	× ***	OMNI ON/OFF, POLY	'MONO' Ignored
Note Number	: True voice	36-96	0-127	
		***	24-108	
Velocity	Note ON	○	*	V=1-127
	Note OFF	×	×	
After Touch	Key's	×	×	
	Ch's	○	*	
Pitch Bender		○	*	
Control Change	1	×	*	Modulation Portamento Volume Release Portamento Switch
	5	○	*	
	7	×	*	
	64	○	*	
	65	○	*	
Prog Change	: True #	○ 0-99	* 0-127	
		***	0-99	
System Exclusive		*	*	
System Common	: Song Pos	×	×	
	: Song Sel	×	×	
	: Tune	×	×	
System Real Time	: Clock	×	×	
	: Commands	×	×	
Aux Messages	: Local ON/OFF	×	×	
	: All Notes OFF	○(123)	○(123-127)	
	: Active Sense	○	*	
	: Reset	×	×	
Notes		* Can be set ○ or X. Memorized even after turning off the power.		

Mode 1 : ONMI ON, POLY Mode 2 : OMNI ON, MONO
Mode 3 : OMNI OFF, POLY Mode 4 : OMNI OFF, MONO

○ : Y
X : N

MEMO

KAWAI

Kawai Musical Instruments Manufacturing Co., Ltd.
200 Terajima-cho, Hamamatsu, Japan

Kawai America Corporation	24200 South Vermont Avenue P.O. Box 0438 Harbor City, California, 90710 U.S.A.
Kawai Canada Music Ltd.	UNIT 1, 6400 Shawson Drive Mississauga, Ontario L5T 1L8, Canada
Kawai Australia Pty. Ltd.	447 Kent Street, Sydney, N.S.W. 2000 Australia
Kawai Europa GmbH	Max-Planck Str. 20-22 4006 Erkrath-Unterfeldhaus West Germany
Kawai Deutschland GmbH	Max-Planck Str. 20-22 4006 Erkrath-Unterfeldhaus West Germany
Kawai Deutschland GmbH U.K. Office	94 Jermyn Street, London SW1 United Kingdom
Kawai (Muziekinstrumenten) Nederland B.V.	Energistraat 10, 1411AT Naarden, Holland
Kawai Musical Inst. Mfg. Co., Ltd. Singapore Representative Office	#04-04 Wellington Building 20 Bideford Road, Singapore 0922