

Digital Piano

KSP 5/10

OWNER'S MANUAL

Advanced Operation

KAWAI

HINTS AND PRECAUTIONS FOR SAFE OPERATION

- **POWER**

Always operate this digital piano from an AC outlet. Double check the voltage, as mistakenly using an outlet with a higher voltage could damage this equipment and present a safety hazard.

- **NOISE**

Use caution when selecting a location for this digital piano, as motors and neon or fluorescent lights can be a source of electrical interference creating noise in the sound output. If such noise should appear, please change locations.

- **HANDLING THE POWER PLUG AND CORD**

Never handle the power plug with moist hands, as this could cause an electrical shock.

Also, be careful not to step on or trip over the cord, as this could cause electrical shorts or breaks in the line.

- **BREAKDOWNS**

During a suspected breakdown, opening up the inside of the unit and removing parts is highly dangerous, so please make sure never to do this! In the event of a suspected breakdown, consult the retailer where you brought the unit or contact your nearest Kawai dealer.

- **PRECAUTIONS AFTER USE**

After use, always be sure to turn off the power.

Leaving the power to the unit on could cause various operating problems.

During extended periods of non-use, remove the plug from the outlet.

- **CLEANING**

Never attempt to clean the instrument with chemicals such as alcohol, thinner or benzine.

When cleaning the outside of the unit, wipe gently with a soft cloth soaked with a solution of water and a neutral detergent.

Clean off the piano keys by wiping with a soft cloth moistened with water.

- **DATA BACKUP BATTERY**

When the internal battery for data backup has exceeded its service life, the record data in the recorder and the contents of the registration memory will be lost. Please replace this battery every 6 to 7 years.

(Contact your dealer.)

Note: This equipment has been tested and found to comply with the limits for a Class B digital device, pursuant to Part 15 of the FCC Rules. These limits are designed to provide reasonable protection against harmful interference in a residential installation. This equipment generates, uses and can radiate radio frequency energy and, if not installed and used in accordance with the instructions, may cause harmful interference to radio communications. However, there is no guarantee that interference will not occur in a particular installation. If this equipment does cause harmful interference to radio or television reception, which can be determined by turning the equipment off and on, the user is encouraged to try to correct the interference by one or more of the following measures:

- Reorient or relocate the receiving antenna.
- Increase the separation between the equipment and receiver.
- Connect the equipment into an outlet on a circuit different from that to which the receiver is connected.
- Consult the dealer or an experienced radio/TV technician for help.

This instrument has been certified to comply with the limits for a class B digital apparatus, pursuant to the Radio Interference Regulations, C.R.C., c. 1374.

This digital piano should be not commercial use but household use.

INTRODUCTION

Thank you for choosing this Kawai KSP Series Digital Piano.

Your new Kawai KSP Series digital piano is a truly innovative instrument offering the very latest in leading-edge music technology. Its development relied upon Kawai's long years of experience and success in the manufacture of musical instruments.

A diverse array of 128 instrument sounds, 64 rhythms for a wide range of pleasing styles, and a powerful auto orchestra capability give you the musical resources to create exciting "full band" performances with just your own two hands!

This manual consists of three parts: a Basic Operation, an Advanced Operation and Auto Chord Progression Chart.

Basic Operation This section explains basic functions of your digital piano for those learning to play for the first time.

Advanced Operation This section explains all the functions of the digital piano in detail. This section will prove useful for those who have mastered the basic section of the manual.

Auto Chord Progression Chart..... This is used with the Auto Chord Progression feature. It includes a sound list and chord form table.

KSP5 / 10 SPECIAL FEATURES

• 128 Realistic Sounds

A total of 128 sounds have been provided, including piano and a wide array of musical instrument sounds and effects used throughout the world.

• 64 Rhythms/Auto Accompaniment Patterns Gathered from Worldwide Genres.

A total of 64 rhythm/auto accompaniment patterns are offered, ranging from folk music to latin styles to the latest popular music. This lets you perform your music along with accompaniments created by top musicians in each genre.

• Creative Auto Accompaniment (Auto Orchestra)

This function provides a "back-up" band to support your performance with a natural, "human" feel.

• Auto Chord Progression Creates an Enjoyable Full-band Performance with Just One Finger

Chord progressions play automatically, allowing you to enjoy a fully accompanied performance as you play melodies with just one finger!

• ONE TWO PLAY Function Lets You Recall Sounds and Panel Settings to Match Each Rhythm

You can now select an ideal sound and panel setting just by choosing a rhythm. If this function is combined with Auto Chord Progression, you can easily achieve the perfect setting for each performance!

• Registration Memory Stores Your Favorite Panel Settings

Settings essential to your performance (sounds, DUAL sound combinations, SPLIT sounds, tempo, etc.) can be stored for immediate recall on any of four buttons.

• Recorder Function Easily Stores Your Performance

Using the recorder to record and replay your performance means you can record different parts of a song or record right- and left-hand parts separately. This will prove useful for piano practice and other functions.

• GM Compatible Sound Source

This digital piano can be used as a 16-channel Multi-Timbral, General MIDI (GM) compatible sound source. This also means that it can play GM song data (supplied by third-party developers) when connected to an external sequencer.

TABLE OF CONTENTS

ASSEMBLY	3
PART NAMES AND FUNCTIONS	5
1 CHOOSING A SOUND	7
2 CHANGING THE TEMPO	9
3 COMBINING TWO SOUNDS (DUAL FUNCTION)	10
4 PLAYING DIFFERENT SOUNDS WITH RIGHT AND LEFT HANDS (SPLIT FUNCTION)	11
5 EXPLORING THE REVERB FUNCTION	13
6 PLAYING RHYTHMS	15
7 PERFORMING WITH AUTO ORCHESTRA	17
AUTO ORCHESTRA	19
STARTING AUTO ORCHESTRA FROM INTRO/FILL-IN	20
ADJUSTING AUTO ORCHESTRA VOLUME	21
CHANGING AUTO ORCHESTRA SOUND RANGE	22
8 THE AUTO CHORD PROGRESSION FEATURE (THE AUTO CHORD PROGRESSION)	23
9 AUTOMATICALLY SELECTING SOUNDS TO MATCH THE RHYTHM (ONE TWO PLAY)	25
10 ADDING AUTO MELODY CHORDS	26
11 INSERTING AUTO FILL-IN	27
12 TRANSPOSING YOUR PERFORMANCE	28
13 STORING PANEL SETTINGS (REGISTRATION MEMORY)	29
14 LISTENING TO THE DEMO SONG	31
15 RESET	32
16 SYSTEM SETTINGS	33
1. TOUCH CURVE SETTINGS	33
2. LEFT PEDAL SETTINGS	34
3. DAMPER PEDAL SETTINGS	35
4. DUAL/SPLIT BALANCE SETTINGS	36
5. SPLIT POINT SETTINGS	37
6. REVERB DEPTH SETTINGS	38
7. PART REVERB DEPTH SETTINGS	39
8. LOCAL CONTROL SETTINGS	40

9. SYSTEM TUNING SETTINGS.....	41
10. TEMPERAMENT SETTINGS.....	42
11. ALL GM ASSIGNMENT SETTINGS	43
12. SYSTEM CHANNEL SETTINGS	44
13. MIDI CLOCK SETTINGS	45
14. MULTI TIMBRE SETTINGS	46
15. SECTION MUTE SETTINGS	48
17 USING THE RECORDER	49
PLAYBACK OF A PERFORMANCE	52
RECORDING SOUNDS ON MULTIPLE TRACKS.....	53
RECORDING AUTO CHORD PROGRESSIONS	55
TRACK BUTTON ON/OFF	56
DELETING TRACK DATA	57
RECORDER PRECAUTIONS.....	58
18 MIDI INTERFACE	59
TRANSMISSION OF PROGRAM CHANGES	62
FACTORY SETTINGS	63
ERROR MESSAGES	64
WAIT, IT'S NOT BROKEN!	65
MAIN SPECIFICATIONS	66
INDEX	67
MIDI IMPLEMENTATION CHART	68

ASSEMBLY (KSP10)

- Be sure to check that all parts are on hand before starting to assemble your unit.
- During disassembly use the procedure below, in reverse order.

■ PARTS PROVIDED

• Side panel ①	2 pcs.	• Screws (long)	4 pcs.
• Back panel ②	1 pc.	• Screws (short)	8 pcs.
• Pedal board ③ (2 pedals)	1 pc.	• Adjuster	1 pc.
		• Screw cap	4 pcs.

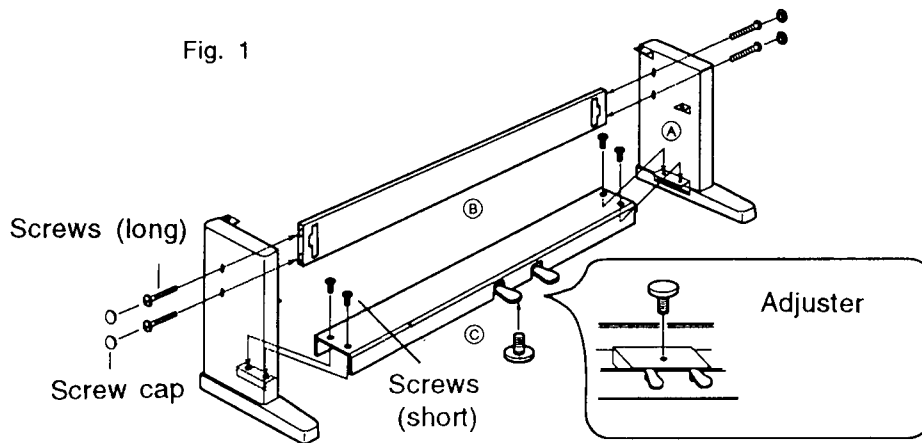

1. Insert the adjuster (height adjusting screw) on ③ from the back about 1 cm. (Fig. 1)
2. Fasten ① and ③ with 4 screws (short). (Fig. 1)
3. Hold ② so that the side with metal fittings faces toward you, and fasten ① and ② with four screws (long). (Fig. 1)

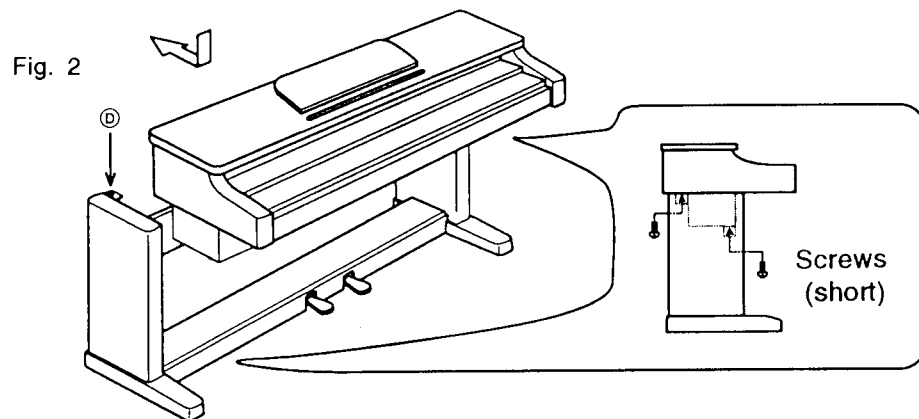

4. Place the piano on the stand so that, when viewed from top, all of metal fittings ④ at the back of the body are visible. Use care so that your hand (supporting the rear part of the piano) is not caught between the side plate and the unit. (Fig.2)
5. Hold the stand tight with your foot, and hold the front of the piano with your hand so that it does not tilt. Slide the body backward until it hooks on to ④. (Fig. 2)
6. Secure the unit to the stand with 4 screws (short). (Fig. 2)
Temporarily tighten the screws, and adjust the position of the piano. Then, tighten all screws securely.

Caution: Be sure to secure the unit to the stand with the screws. If you fail to do so, the unit could fall from the stand, causing damage or personal injury.

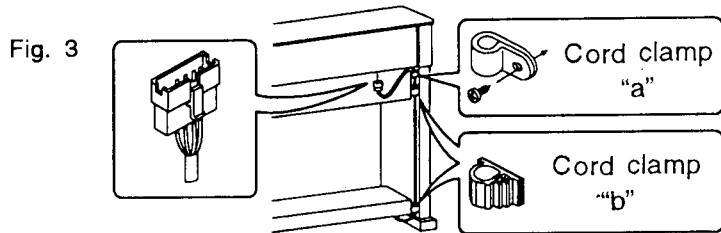

7. Insert the pedal connection cord that comes from © into the unit's pedal terminal and fasten with clamps "a" and "b". (Fig. 3) (Insert clamp "a" after removing the screw.)

Fig.4
Fully assembled view

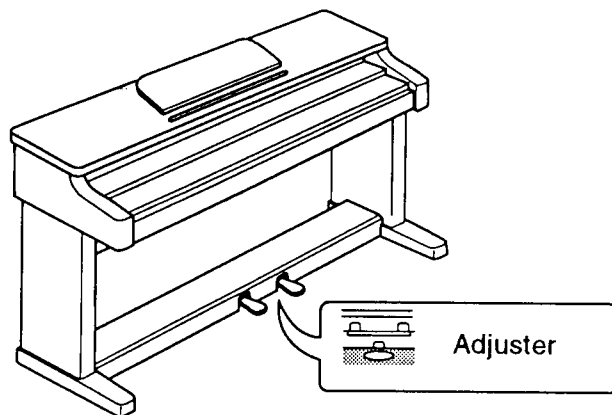

8. Turn the adjuster (installed on the back of ©) until it touches the floor to support the pedal board.(Fig.4)

Refer to attached sheet of "ST-76D" for KSP5's assembling procedure.

PART NAMES AND FUNCTIONS

- ① **SYSTEM** button (refer to p. 33)
Touch curve and pedal, set with MIDI etc.
- ② **REVERB** button (refer to p. 13)
Adds reverb to the sound
- ③ **TRANPOSE** button (refer to p. 28)
Transposes the musical steps in half-step intervals.
- ④ **SPLIT** button (refer to p. 11)
Use to play different sounds on the right and left sides of the keyboard.
- ⑤ **MASTER VOLUME** lever
Adjusts the overall volume of the digital piano.

- ⑱ **Rhythm** button (refer to p. 15)
Selects the rhythm to be played.
- ⑲ **Rhythm lamp** (refer to p. 15)
Displays the selected rhythm name list.
- ⑳ **FILL-IN 1** button (refer to p. 16, 20)
- ㉑ **FILL-IN 2** button (refer to p. 16, 20)
The FILL-IN pattern for the rhythm or auto accompaniment is played.
- ㉒ **START STOP** button (refer to p. 16)
Pressing this button starts the rhythm. Pressing again stops it.
- ㉓ **INTRO/ENDING** button (refer to p. 16)
When the rhythm is stopped, this button plays the intro pattern -- followed by the basic pattern. When the rhythm is playing, the button initiates the ending pattern and then stops play.
- ㉔ **BEAT** lamp
This lamp flashes in time with the rhythm tempo during play.

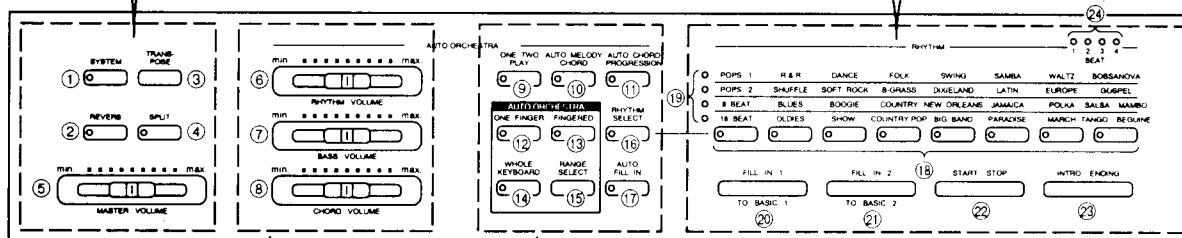

- ⑥ **RHYTHM VOLUME**
Adjusts the auto accompaniment rhythm volume
- ⑦ **BASS VOLUME**
Adjusts the auto accompaniment bass volume.
- ⑧ **CHORD VOLUME**
Adjusts the auto accompaniment chord volume.

- ⑨ **ONE TWO PLAY** button (refer to p. 25)
Automatically selects sounds to match the rhythm.
- ⑩ **AUTO MELODY CHORD** button (refer to p. 26)
Adds chords to melodies played in single notes.
- ⑪ **AUTO CHORD PROGRESSION** button (refer to p. 23)
Automatically plays a chord progression matching the rhythm.
- ⑫⑬⑭ **ONE FINGER, FINGERED, WHOLE KEYBOARD** button (refer to p. 17)
Used for auto accompaniment play.
- ⑮ **RANGE SELECT** button (refer to p. 22)
Selects the range of the auto accompaniment chord parts.
- ⑯ **RHYTHM SELECT** button (refer to p. 15)
Used to select any rhythm listed on the panel.
- ⑰ **AUTO FILL IN** button (refer to p. 27)
Automatically plays a FILL-IN pattern every 4 bars.

- ②⑤ **DISPLAY screen**
Displays names and modes of the various rhythms and sounds.
- ②⑥ **CURSOR button** (refer to p. 9)
Changes the position of the cursor (horizontal bar) on the screen.
- ②⑦ **TEMPO VALUE button** (refer to p. 9)
Changes the settings of tempo and sound numbers indicated by the cursor on the display.

- ③① **TRACK button** (refer to p. 49, 56)
Selects the track button to record or replay separate right or left hand parts, or separate sounds.
- ③② **REC REGIST button** (refer to p. 29, 50)
Used for storing various settings with the Registration button for making recordings, etc.
- ③③ **PLAY/STOP button** (refer to p. 51, 52)
Plays and also stops the current song.
- ③④ **SONG SELECT button** (refer to p. 50)
Selects songs when using the recorder function.

- ③⑤ **DEMO button** (refer to p. 31)
Plays the demonstration song.

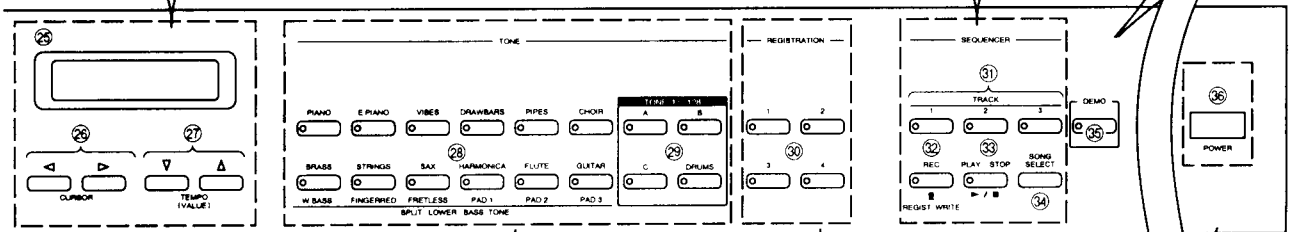

(KSP10)

- ②⑧ **Sound Select buttons** (refer to p. 7, 8)
Selects the sounds for the performance.
- ②⑨ **Sound Select buttons** (refer to p. 7, 8)
Selects the sounds for the performance. The sounds for these buttons can be changed.

- ③⑥ **REGISTRATION button** (refer to p. 29)
This button stores a combination of sounds, rhythms and volume, etc. This data can be recalled when needed, with one button.

- ③⑦ **POWER switch**
Turns the power ON and OFF.

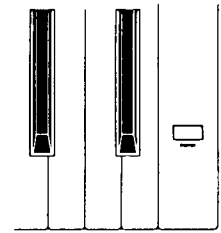

(KSP5)

- ③⑦ **LINE OUT terminals**
Use these terminals to route a sound to other external equipment such as amps and stereos.
- ③⑧ **LINE IN terminals**
Use these terminals to route sounds from external equipment (such as stereos and CD players), to be played through the built-in speakers.
- ③⑨ **MIDI terminals**
Use these terminals to connect other MIDI instruments.

REAR PANEL

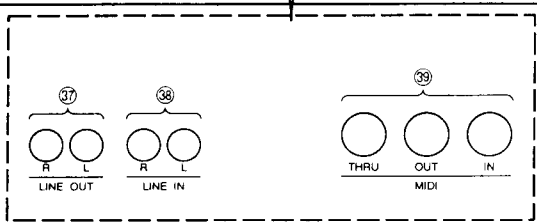

1 CHOOSING A SOUND

This digital piano incorporates 128 sounds and 7 drum sets, giving you a wide variety of choices.

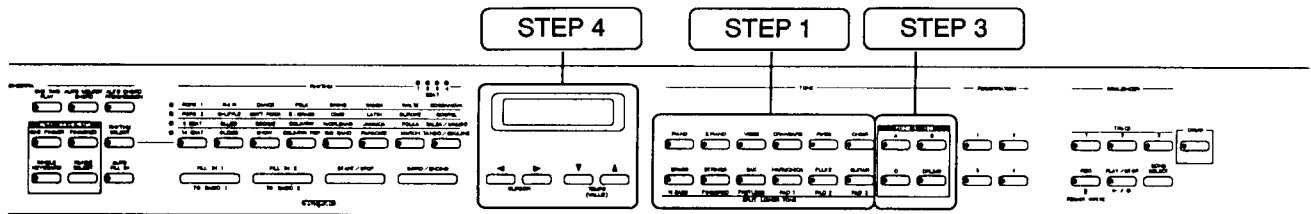

STEP 1

Press the button corresponding to your favorite sound shown on the panel.

For instance, if the FLUTE button is pressed, the lamp for this button lights and the flute sound is chosen.



STEP 2

A beautiful flute sound can be heard when a key is pressed.

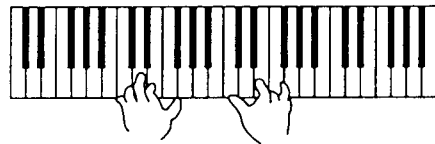

To play sounds other than those listed on the panel:

STEP 3

Press any one of the A, B or C buttons.

For instance, if the A button is pressed, the trombone sound is chosen and the name is shown in the display.

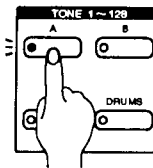

058 Trombone
POPS 1 ♩=120

STEP 4

Press the TEMPO (VALUE) button several times while watching the display. Notice that the sounds change. When the button is held down, the numbers change in increments of 10. Select the sound you like from a total of 128 sounds, numbering from 001 to 128.

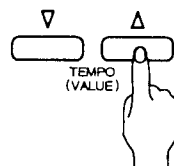

066 AltoSax
POPS 1 ♩=120

(Refer to the 128 sound list on the back cover page of the Auto Chord Progression Chart.)

- When selecting a sound in this way, it is automatically assigned to the button you pressed, and remains even if the power is off. Please assign your favorite sounds to the A - C buttons for instant recall.

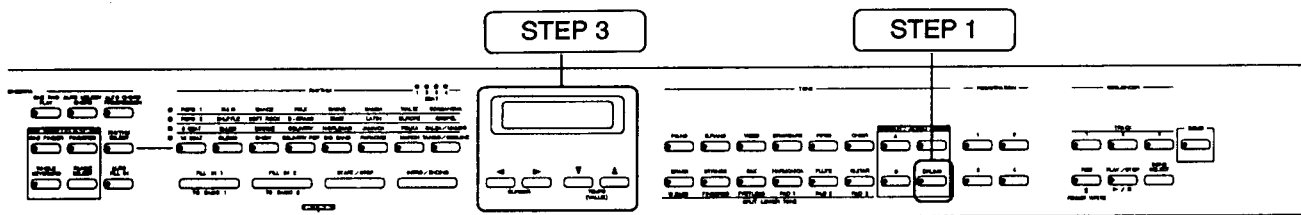
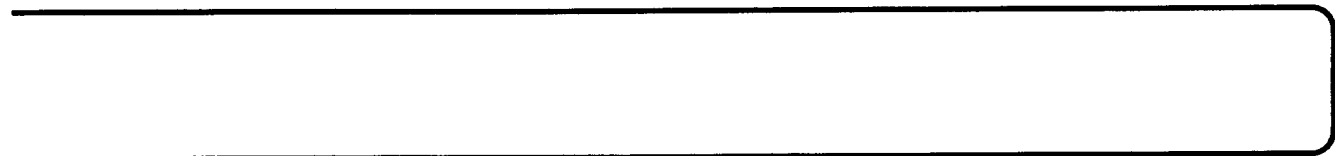

To play the drum sound:

STEP 1 Press the DRUMS button.
 The standard set is chosen from among the 7 drum sets and is shown on the display.

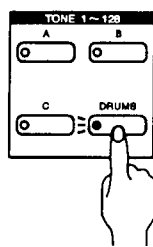

DR1 STANDARD
 POPS 1 ♩=120

STEP 2 When the keys are pressed, various drum and percussion sounds will be heard.

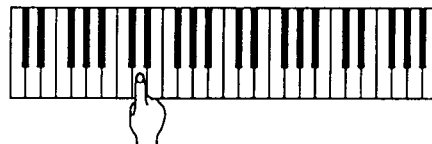

STEP 3 Press the TEMPO (VALUE) button several times to change the drum set.

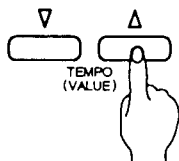

DR2 ROOM
 POPS 1 ♩=120

- STANDARDPlays a traditional drum set assortment.
- ROOMPlays a lighter-sounding drum set.
- POWERPlays a powerful drum set.
- ELECTROPlays an electronic drum set.
- BOBPlays an artificial drum set used for house mixing.
- JAZZPlays a jazz drum set.
- ORCHSTRPlays timpani sounds like those used in orchestras.

(Refer to page 42 of the "Auto Chord Progression Chart" for the sound layout of each drum set.)

When selecting a drum set in this way, it is automatically assigned to the DRUMS button, and remains even if the power is off.
 Please assign your favorite sounds to the DRUMS buttons for instant recall.

- The SPLIT button cannot be operated during DRUMS selection. (Refer to p. 11)
- Auto Orchestra cannot be operated during DRUMS selection. (Refer to p. 17)

2 CHANGING THE TEMPO

This page teaches you how to adjust tempo by changing the number that appears in the display.

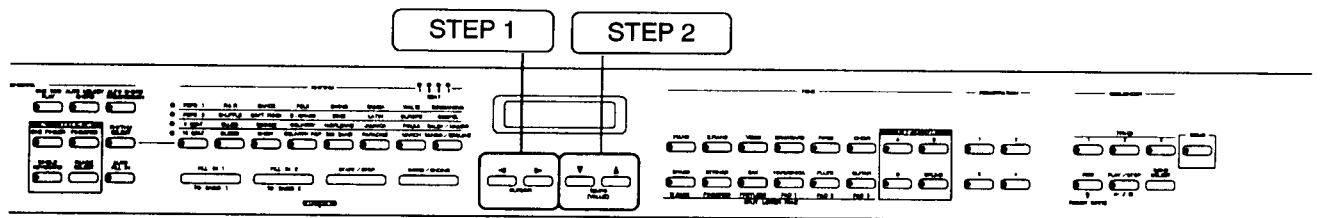

To change the tempo:

- STEP 1** Press the CURSOR button several times to move the cursor beneath TEMPO.
(The cursor may not move, depending on the screen menu.)

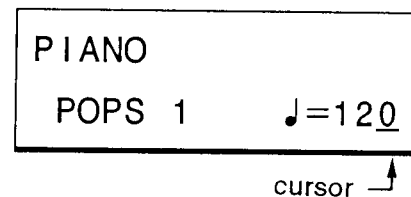
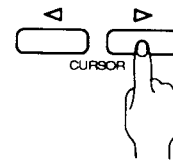

- STEP 2** Press the TEMPO (VALUE) button several times to change the tempo setting.

When this button is held down, the numbers change in increments of 10.

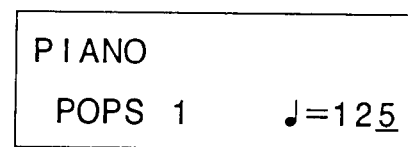
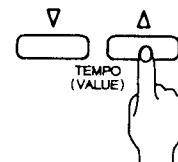

As shown above, numbers and settings in the display can be changed by moving the cursor with the CURSOR button and then changing the number or setting with the TEMPO (VALUE) button. (In some cases the cursor position may be stationary, depending on the type of screen menu. Also numbers and settings may have been preset.)

3 COMBINING TWO SOUNDS (DUAL FUNCTION)

A fuller sound can be obtained by combining two sounds. This is called the DUAL function.

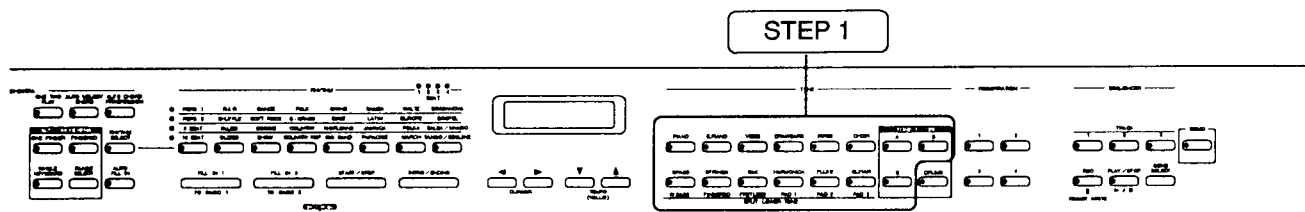

STEP 1 Press the buttons for two of your favorite sounds simultaneously.

In this example, piano and pipe organ sounds are combined and then displayed on the screen as shown at the right.

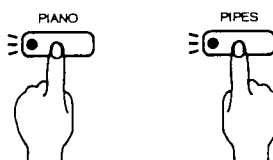

PIANO +PIPES
POPS 1 ♩=120

STEP 2 Press a key and the two combined sounds will be heard.

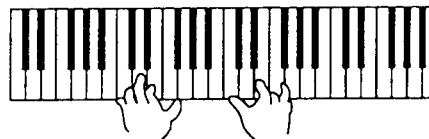

- ★ Any of the 128 sounds (except for drums) can be combined with the DUAL function using the A, B, and C buttons.
A number display for sounds stored with the A, B, C buttons is shown.
For instance, simultaneously pressing the PIANO button and A button gives the following display.

PIANO +GM058
POPS 1 ♩=120

→ DUAL function for piano and trombone No. 058

Move the cursor as shown in the above display with the CURSOR button.
Pressing the TEMPO (VALUE) button changes the A button sound description.

This function is convenient for finding your favorite sound combination by listening and comparing various sounds.

• The volume balance of the two sounds can also be changed. (Refer to p. 36)

4 PLAYING DIFFERENT SOUNDS WITH RIGHT AND LEFT HANDS (SPLIT FUNCTION)

You can play separate sounds for left hand (lower keyboard) and right hand (upper keyboard) with the SPLIT function. While playing a melody with your right hand, you can play chords or bass with your left hand.

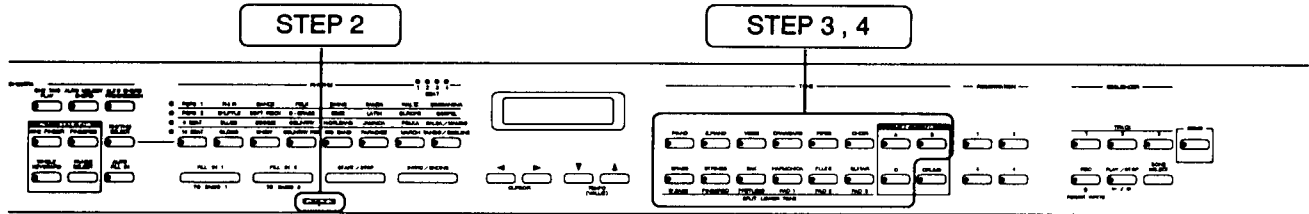

STEP 1 Press the SPLIT button. The lamp for that button will light.

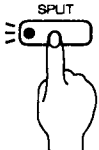

STEP 2 Keeping the [SPLIT POINT] dividing line in mind (between G3 and G#3), play separate sounds on the left and right.

Lower keyboard sounds	Upper keyboard sounds	★When pressing SPLIT button, the following sounds are assigned to upper/lower keyboard. upper: The sound currently selected lower: W. BASS
↓	↓	
W. BASS / PIANO POPS 1 ♩ = 120		
		PIANO E PIANO [PIANO] [E PIANO]
		STRINGS W. BASS [STRINGS] [W. BASS]
		← The lamps for the upper and lower keyboard sound buttons will light.
		SPLIT LOWER TONE

STEP 3 To change the sound assigned to the upper keys, press the sound button you want to assign.



STEP 4 To change the sound assigned to the lower keys, press the sound button you want to assign while holding down the SPLIT button.

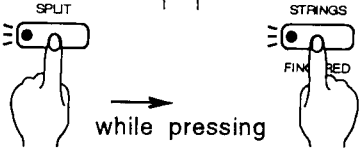

When pressing the button once, the sound shown below the button is selected.

STRINGS
[STRINGS] [FINGERED]
Press once for lower sound (FINGERED BASS).

To select the sound shown above the button, press the button once again.

STRINGS
[STRINGS] [FINGERED]
Press twice for upper sound (STRINGS).

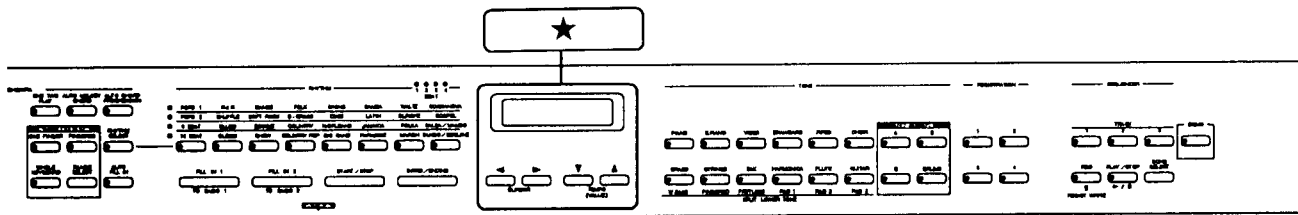

- The DRUMS sound cannot be selected when SPLIT is "ON".
- The lower keyboard will sound about one octave higher than normal when played, except when using the following eight sounds:
 - 033 Wood Bass = W.BASS
 - 034 FingerBass = FINGERED
 - 035 PICKBASS
 - 036 FRETLESS = FRETLESS
 - 037 SlapBass1
 - 038 SlapBass2
 - 039 SynBass1
 - 040 SynBass2

★ All sound buttons can be set with SPLIT except for the DRUMS button. All 128 sounds can be freely set in combinations by using the A, B and C buttons. Sounds stored with the A, B and C buttons are set in a line No. display format. For instance, simultaneously pressing the PIANO button and A button SPLIT gives the following display:

P I A N O /GM058 P O P S 1 ♪=120	→	Piano on lower keyboard and trombone No. 058 on the upper keyboard
-------------------------------------	---	---

Move the cursor with the CURSOR button as shown in the display below.

P I A N O /GM05 <u>8</u> P O P S 1 ♪=120

Pressing the TEMPO (VALUE) button changes the A button sound description. This function will help you find your favorite sound combination by listening and comparing various sounds.

• The SPLIT point can also be changed. (Refer to p. 37)
 • The sound balance for the lower and upper keyboard can also be adjusted. (Refer to p. 36)

5 EXPLORING THE REVERB FUNCTION

You can use the reverb function to enhance your performance. Reverb adds a pleasing echo effect to any sound, providing a richer character to your music.

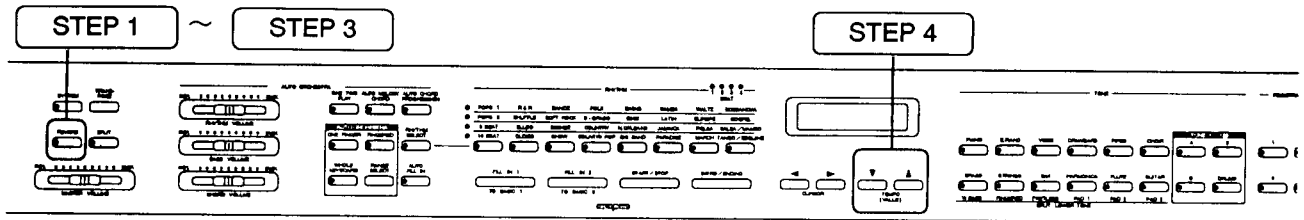

STEP 1 The reverb effect is being activated when the REVERB lamp is lit. (The reverb effect is active when power is first turned on.)



STEP 2 Pressing the reverb button turns off the REVERB lamp and cancels the reverb effect.



STEP 3 Pressing the reverb button again lights the REVERB lamp and activates the reverb effect. For a few seconds, the display will show the message in the figure on the right.



REVERB TYPE
= LARGE ROOM

STEP 4

Pressing the TEMPO (VALUE) button repeatedly while this message is displayed allows you to change the type of reverb as desired.
(After about 3 seconds, the display will return to normal.)

REVERB TYPE
= HALL

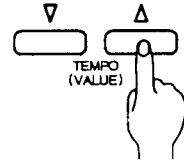

Types of reverb are listed below:

- SMALL ROOM Similar to playing in a small room that produces a pronounced echo.
- LARGE ROOM Provides a longer reverb sound than the above SMALL ROOM.
- HALL Similar to playing in a small concert hall.
- CHURCH Similar to playing in large concert hall or church.
- COSMIC Conveys a feeling of wide and open spaces.
- DELAY Produces a delayed echo.

When the reverb type in the display is changed, the new reverb effect will be activated after about 2 seconds.

6 PLAYING RHYTHMS

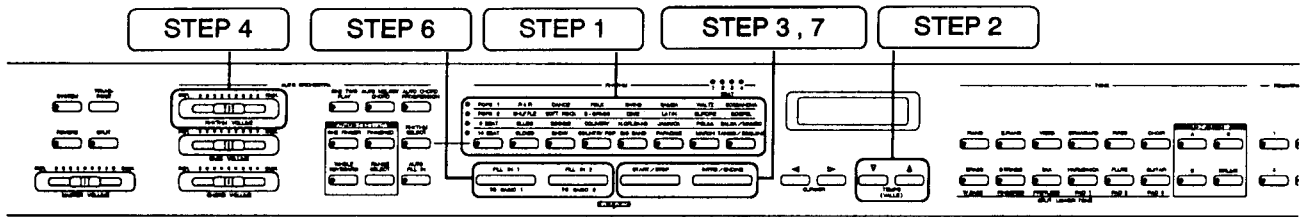

STEP 1

Select a favorite rhythm with the rhythm buttons.

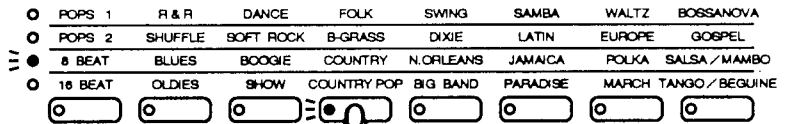

For example, to select COUNTRY, press the button below COUNTRY several times. Its lamp will light as shown in the figure on the upper right. The rhythm name is shown in the display.



Pressing the RHYTHM SELECT button while COUNTRY is still displayed allows you to select a different COUNTRY rhythm. (Variation Pattern)

RHYTHM SELECT



⤴ The variation pattern has been selected.

This function allows you to select two types of patterns for each rhythm name.

STEP 2

Adjust the speed of the rhythm (tempo). Press the TEMPO (VALUE) button to adjust the tempo as needed.

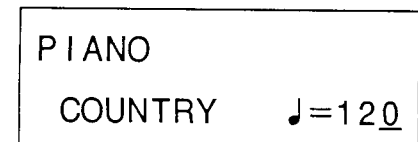
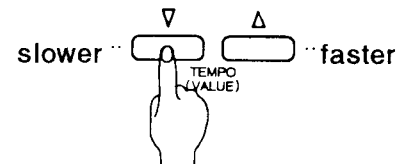

STEP 3 Start the rhythm.

- Press the START/STOP button to start the rhythm immediately.
- Press the INTRO/ENDING button to start the rhythm with the preset introduction.

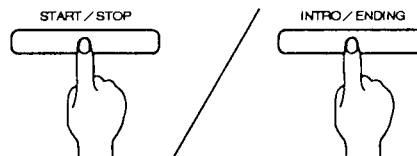

STEP 4 Adjust the rhythm volume as needed with the RHYTHM VOLUME slide control.

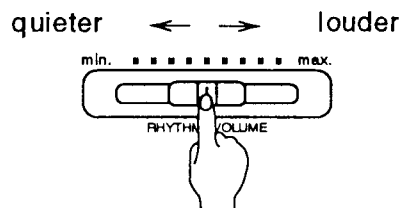

STEP 5 Play in time with the rhythm.

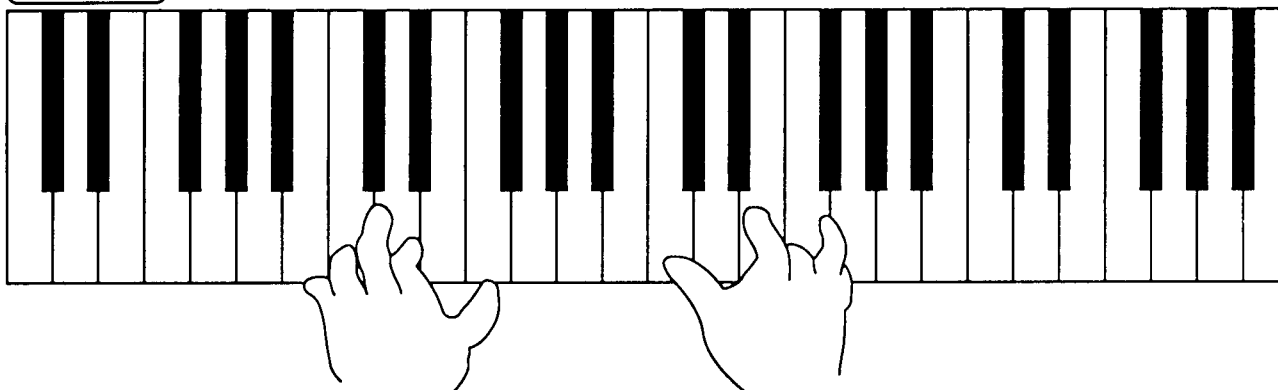

STEP 6 To change the character of the rhythm (FILL-IN):

- Press FILL-IN 1 to change to basic pattern 1 (BASIC 1).
- Press FILL-IN 2 to change to basic pattern 2 (BASIC 2).

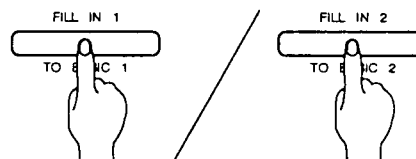

- In this digital piano, 2 basic patterns can be selected for 1 rhythm.
- Basic pattern 1 (BASIC 1) is played right after rhythm or auto accompaniment is started or after FILL-IN 1 is selected.
- Basic pattern 2 (BASIC 2) is played right after FILL-IN 2 is selected. Basic pattern 2 (BASIC 2) is recommended for the "higher intensity" portions of a song.

STEP 7 Stop the rhythm.

- Press the START/STOP button to stop the rhythm immediately.
- Press the INTRO/ENDING button to stop the rhythm with the preset ending pattern.

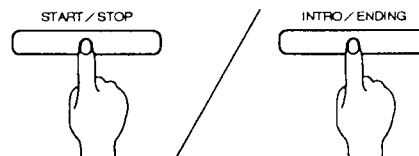

• During rhythm play, changing between DRUMS and other sounds cannot be done.

7 PERFORMING WITH AUTO ORCHESTRA

The Auto Orchestra (auto accompaniment) function allows you to sound like an entire band just by playing left-hand chords.

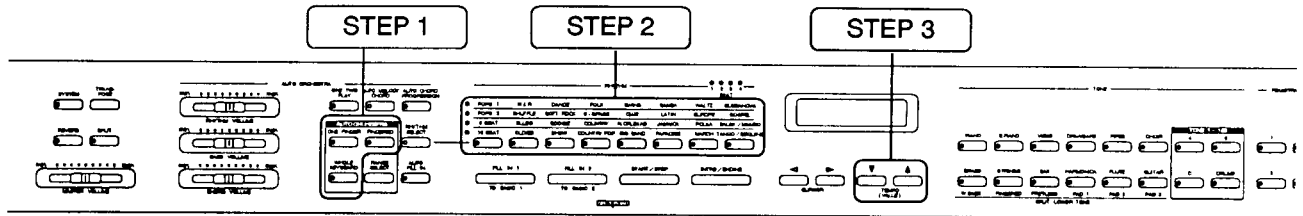

STEP 1

Press the ONE FINGER button, the FINGERED button or the WHOLE KEYBOARD button.

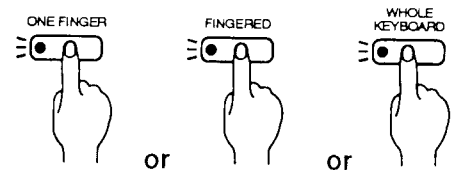

- When the ONE FINGER button is pressed

Auto Orchestra is controlled with just one finger, so that full left-hand chords do not have to be played. For example, you can select a major chord with just one finger (on the root note) and select other types of chords by pressing down keys with two or more fingers.

- When the FINGERED button is pressed

Auto Orchestra is controlled by playing full chords with the left hand.

- When the WHOLE KEYBOARD button is pressed

Auto Orchestra can be controlled by pressing down a chord anywhere on the keyboard. In addition, the bass of the Auto Orchestra accompaniment is controlled by the lowest key played on the lower keyboard.

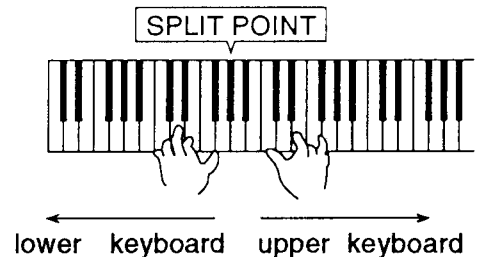

STEP 2

Select a favorite rhythm with the rhythm buttons.

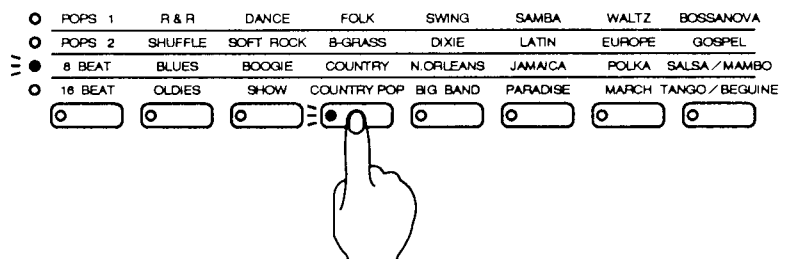

STEP 3 Adjust the speed of the rhythm (tempo). Press the TEMPO (VALUE) button to adjust the tempo as needed.

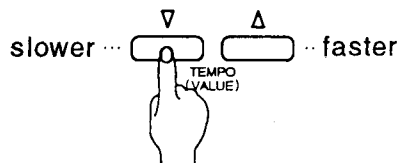

STEP 4 Start the accompaniment.

Auto Orchestra starts when a left hand chord or a single key (in ONE FINGER mode) is pressed. As shown in the figure on the right, hold down keys that are to the left of the position labeled as the SPLIT POINT.

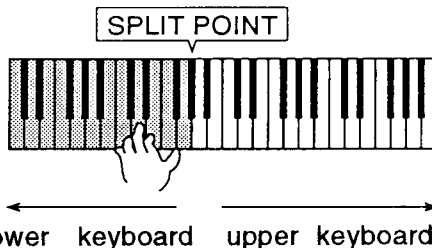
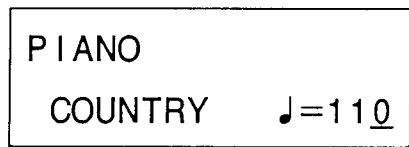

NOTE: Auto Orchestra will not start when selecting the DRUMS sound.

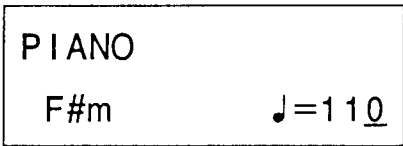

⌞ The chord which was pressed is displayed.

Refer to p. 44 of the Chord Progression Chart for details on holding down chords.

STEP 5 Play a melody with your right hand in time with the accompaniment. Your right hand should use the keys identified in the figure on the right. These keys are found to the right of the position labeled as the SPLIT POINT.

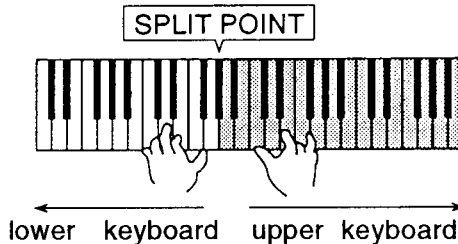

NOTE: During playing in WHOLE KEYBOARD mode, you can start auto accompaniment by pressing a chord on any range of the keyboard. The sound currently selected will be heard when any keys are played.

STEP 6 Stop the accompaniment. Press the START/STOP button or the INTRO/ENDING button.

To cancel auto accompaniment, push the button for the AUTO ORCHESTRA lamp which is lit. When the lamp turns off, auto accompaniment is cancelled.

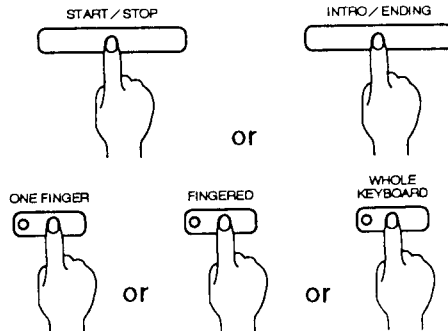

- SPLIT POINT can be changed as needed. (Refer to p. 37)
- During Auto Orchestra, changing the sound to DRUMS cannot be done.

AUTO ORCHESTRA

Functional differences between the three AUTO ORCHESTRA buttons:

	ONE FINGER	FINGERED	WHOLE KEYBOARD
Level / Style	For beginners	For players accustomed to organ and jazz piano	For players accustomed to contemporary and classical piano
Chord sensor keys	Lower keyboard	Lower keyboard	All keys
Bass sensor keys	Lower keyboard	Lower keyboard	All keys. However, the lowest key pressed controls the bass.
Sensor parameters	Chord is detected when 1 or more keys are pressed.	Chord is detected when 3 or more keys are pressed.	Chord is detected when 3 or more keys are pressed.
Generating tones	Lower keyboard notes will not be heard when they are played (except when SPLIT is selected).	Lower keyboard notes will not be heard when they are played (except when SPLIT is selected).	All notes are heard when played.

STARTING AUTO ORCHESTRA FROM INTRO/FILL-IN

Starting Auto Orchestra with INTRO/FILL-IN provides a more exciting beginning to your songs.

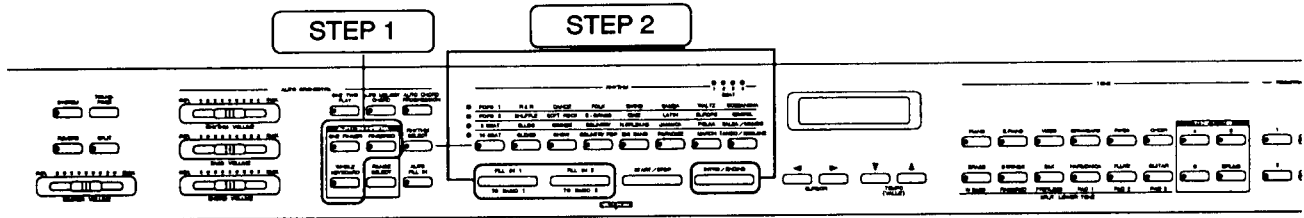

STEP 1 Press one of the three Auto Orchestra buttons.

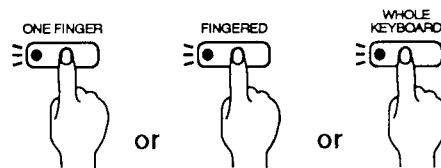

STEP 2 Select the type of start you desire.

- To start with an INTRO, press the INTRO/ENDING button.
- To start with FILL-IN 1, press the FILL-IN 1 button.
- To start with FILL-IN 2, press the FILL-IN 2 button.

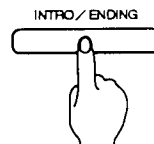

PLAY CHORD
→ INTRO START

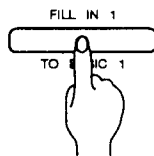

PLAY CHORD
→ FILL1 START

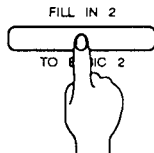

PLAY CHORD
→ FILL2 START

STEP 3

SPLIT POINT

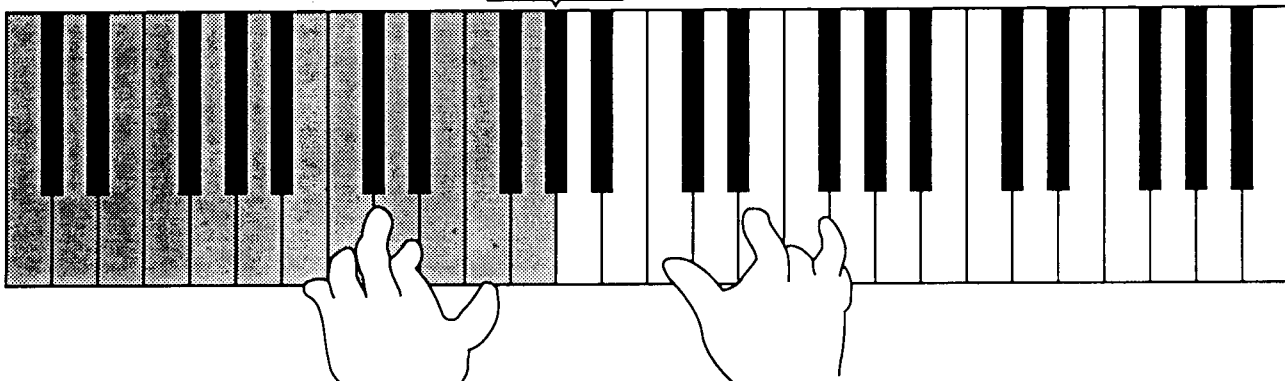

Hold down a chord and start Auto Orchestra.
Hold down a major chord and a "major" intro will start.
Hold down a minor chord and a "minor" intro will start.

ADJUSTING AUTO ORCHESTRA VOLUME

The volume of each Auto Orchestra part can be adjusted.

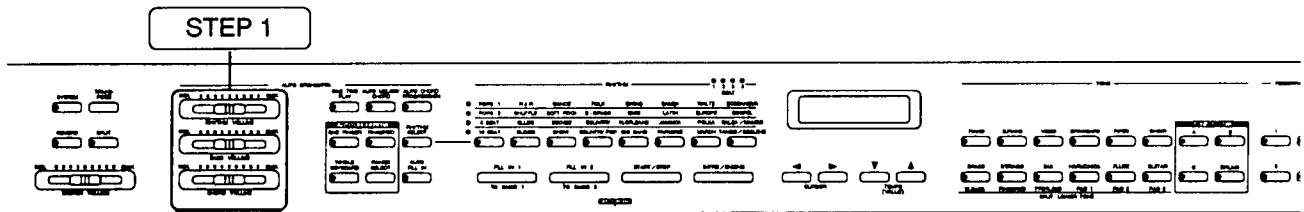

STEP 1 Try using the volume control for each Auto Orchestra part:

- Adjust the drum/percussion volume as desired with the RHYTHM VOLUME control.

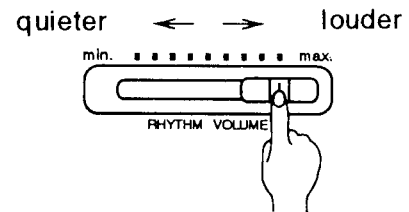

- Adjust the bass volume as desired with the BASS VOLUME control.

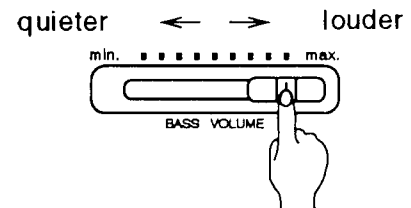

- Adjust the chord volume as desired (for sounds such as piano accompaniment) with the CHORD VOLUME control.

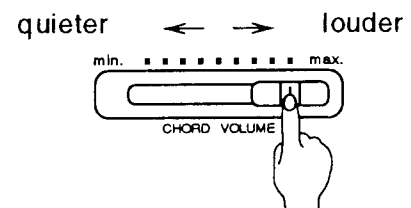

- No sound can be heard when the controls are moved all the way to the left.
- When the Master Volume Control is set to a low level, the sound levels will not increase even when the "part" volume controls are increased.

CHANGING THE AUTO ORCHESTRA SOUND RANGE

In Auto Orchestra, the sound range of the accompaniment can be adjusted, even during a chord change. The following describes how to change these sound ranges.

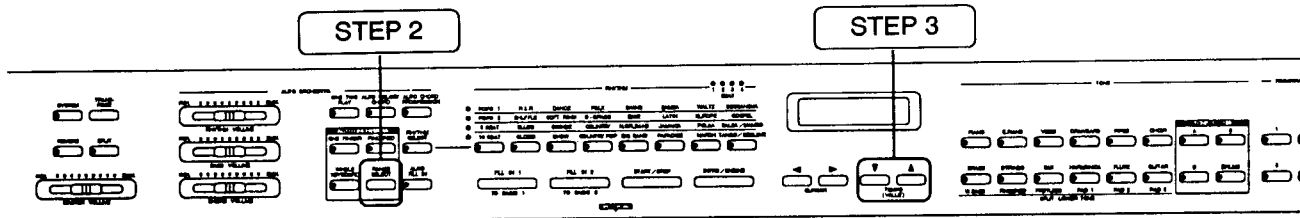

STEP 1 Start the Auto Orchestra (refer to p. 17).

STEP 2 Press the RANGE•SELECT button.

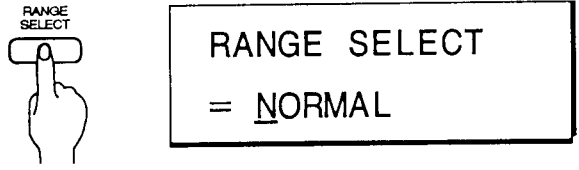

STEP 3 Press the TEMPO (VALUE) button several times to adjust the setting.

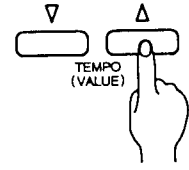

- NORMAL ..Plays the Auto Orchestra in the normal sound range.
- HIGHPlays a portion of the Auto Orchestra in a higher sound range.
- LOWPlays a portion of the Auto Orchestra in a lower sound range.

STEP 4 After several seconds, the screen returns to the normal display.

- With certain types of rhythms and chords, there may be a case in which the sound range will not change even if you changed the above setting. However, the sound range settings will always be in effect while progressing through different chords.
- Try each of the above sound range settings while playing different chords to get acquainted with this feature.

• RANGE•SELECT can be adjusted even when rhythm/accompaniment is not running.

8 ENJOYING THE AUTO CHORD PROGRESSION FEATURE

This digital piano offers 64 types of rhythm patterns -- with automatic chord progressions to match each rhythm. The Auto Chord Progression feature allows you to select from a variety of preset chord progressions for each rhythm. Try using Auto Chord Progression while following the chords on the enclosed Auto Chord Progression Chart to see how enjoyable this feature can be.

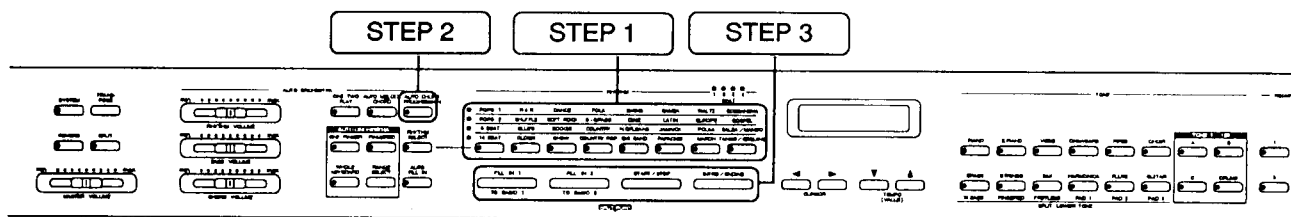

STEP 1 Select a rhythm.
(POPS 1 was chosen in this case.)

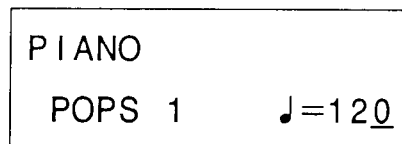

STEP 2 Press the AUTO CHORD PROGRESSION button.

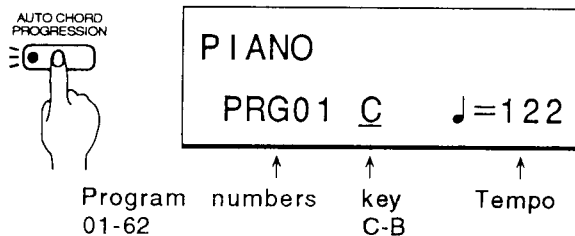

The number of the chord progression (PRG No. 1), the key (C) and the tempo (122) which match this rhythm are displayed.

When changing the chord progression (PRG), key or tempo, move the cursor to the position you want to change (with the CURSOR button). Then, change the setting with the TEMPO (VALUE) button.

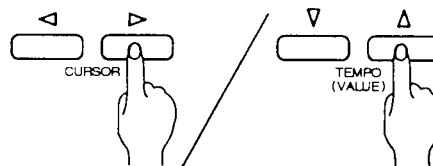

Refer to the Auto Chord Progression Chart for information on chord progressions (PRG).

- AUTO FILL-IN is cancelled when AUTO CHORD PROGRESSION is turned on.
- AUTO CHORD PROGRESSION cannot be turned on during rhythm play or during Auto Orchestra play.

(THE AUTO CHORD PROGRESSION)

STEP 3 Press the START/STOP button.

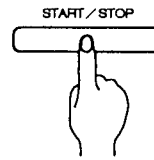

Auto Orchestra begins with the INTRO and the chord progression starts automatically. At the conclusion of the INTRO, the chords and notes will begin to appear in the display.

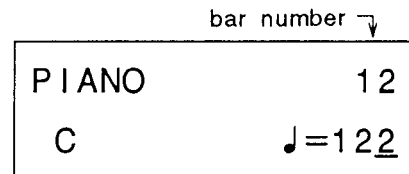

The chord is displayed

STEP 4 Play in time with the accompaniment.

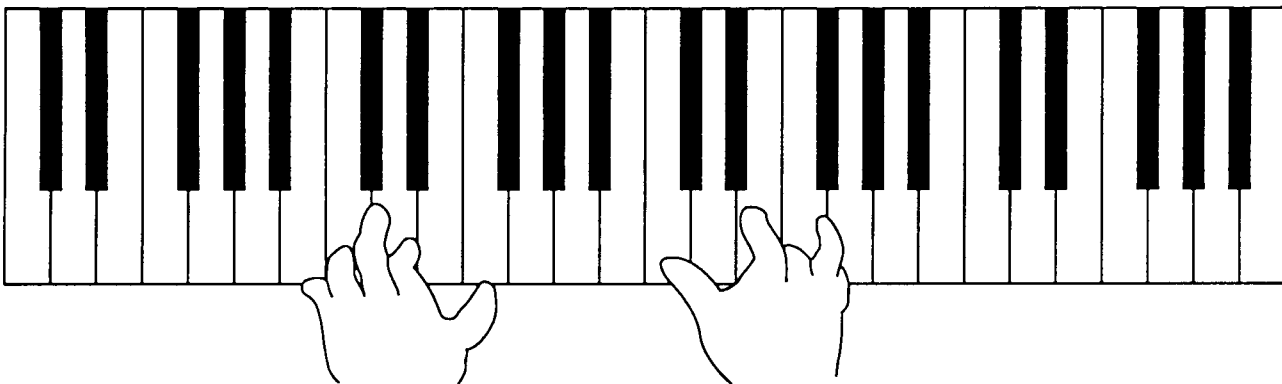

STEP 5 Auto Orchestra will conclude automatically with the ending pattern, but you can press the START/STOP button to finish immediately without the ending.

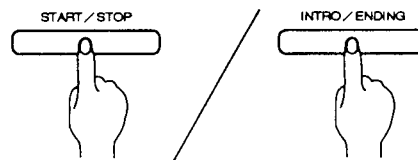

To jump to the ending pattern at any time, press the INTRO/ENDING button.

- Play some music for your enjoyment using the enclosed Chord Progression Chart.
- During Auto Chord Progression, a FILL-IN cannot be inserted with the FILL-IN button.
- During Auto Chord Progression, the AUTO FILL-IN function cannot be operated.
- During Auto Chord Progression, the chord progression (PRG), keys and tempo will not change, even if you change to a different rhythm.

- If you simultaneously use the ONE TWO PLAY function (refer to p. 25), you can enjoy playing with optimal settings of sounds and reverb.

• Auto Chord Progression can also be started using the INTRO/ENDING, FILL-IN1 and FILL-IN 2 buttons.

9 AUTOMATICALLY SELECTING SOUNDS TO MATCH THE RHYTHM (ONE TWO PLAY)

The "ONE TWO PLAY" function automatically selects settings such as tempo, sounds, DUAL functions and reverb to match each of the 64 rhythms.

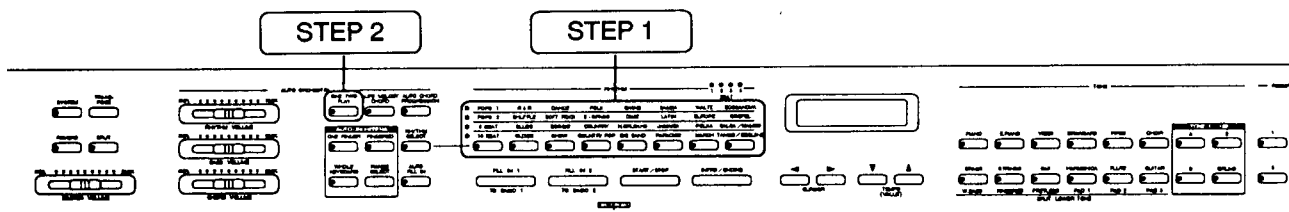

STEP 1 Select a rhythm.

STEP 2 Press the ONE TWO PLAY button.

A suitable combination of sounds, tempo, and effects which matches the rhythm you selected is automatically chosen.

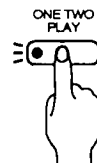

STEP 3 Press the ONE TWO PLAY button once more to cancel ONE TWO PLAY. Its lamp will turn off. The panel settings will be restored to their original setting.



- The rhythm can also be changed when the ONE TWO PLAY button is pressed and its lamp is lit.
- Note that the registration memory settings cannot be recalled when the ONE TWO PLAY function is on.

10 ADDING AUTO MELODY CHORDS

The "Auto Melody Chord" function adds two harmony notes to any melody played with one finger of your right hand. The harmony notes added are determined by the chords you play with your left hand on the lower keyboard.

STEP 1, 2

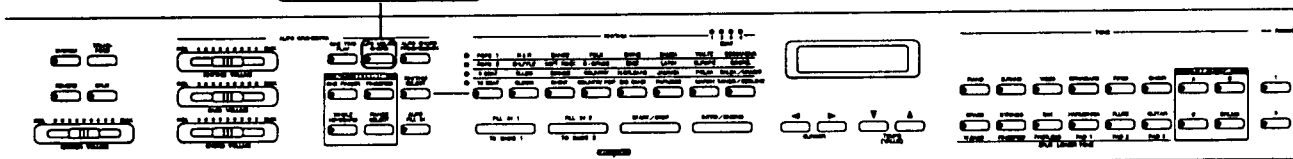

STEP 1 Press the AUTO MELODY CHORD button.

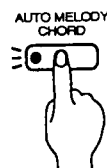

- The keys are divided into upper and lower keyboard.

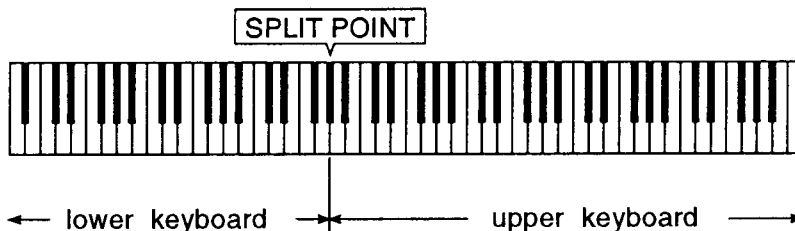

- When a chord is held down on the lower keyboard, harmony notes are added to the sound played on the upper keyboard.

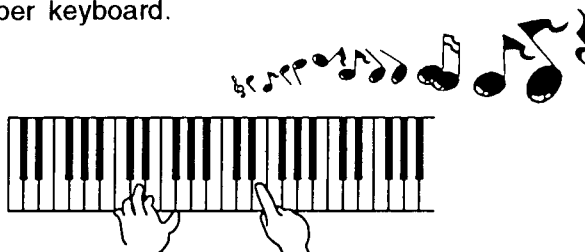

A melody played with just one finger sounds like a melodic sequence of full chords.

STEP 2 Press the AUTO MELODY CHORD button to cancel the Auto Melody Chord feature. The lamp will turn off and the Auto Melody Chord function will be cancelled.

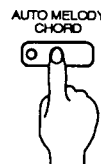

11 INSERTING AUTO FILL IN

A FILL-IN can automatically be added every four bars when this function is used.

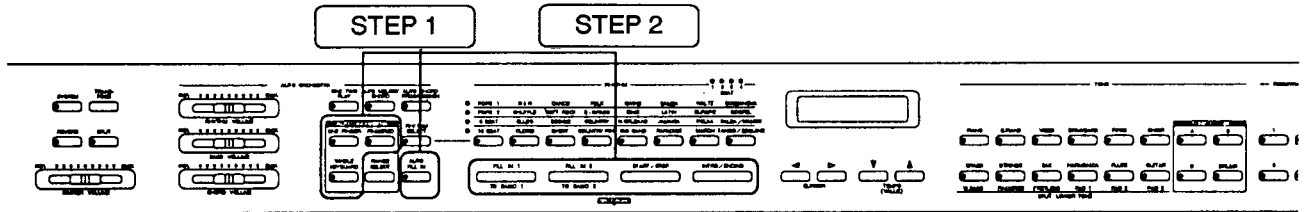

STEP 1 Press the AUTO FILL-IN button.



STEP 2 Start rhythm and auto accompaniment. A FILL-IN will automatically be played every four bars.

FILL-IN 1 will be played when basic pattern 1 (BASIC 1) is selected.
FILL-IN 2 will be played when basic pattern 2 (BASIC 2) is selected.

STEP 3 Press the AUTO FILL-IN button again to cancel the AUTO FILL-IN function.



• The AUTO FILL-IN function is cancelled when the Auto Chord Progression feature is turned on.

12 TRANSPOSING YOUR PERFORMANCE

This digital piano offers a transpose function which lets you play a song in any key. The pitch of the piano can be adjusted in half-tone units, allowing you to play a song in the key of C but hear it in another key. The transpose feature is especially valuable when accompanying a singer who wants a song in a difficult key that accomodates his/her vocal range. The transpose feature lets you play the singer's sheet music in its normal key, while letting the singer hear the sound in his/her key.

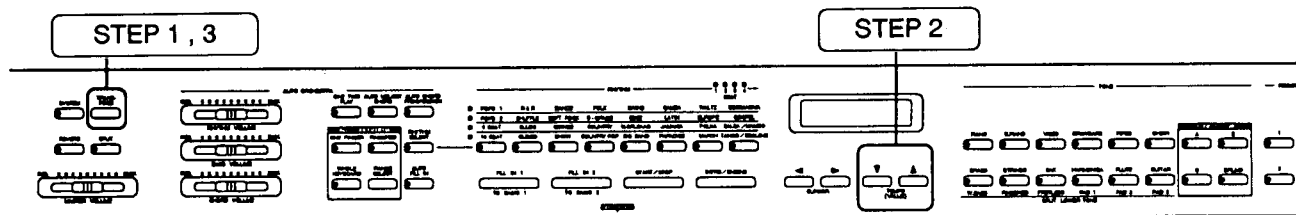

STEP 1 Press the TRANSPOSE button. This activates the Transpose mode. The present status is shown in the display.

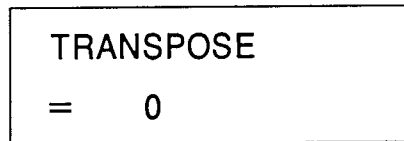

STEP 2 Press the TEMPO (VALUE) button to adjust the setting up or down in half-tone increments.

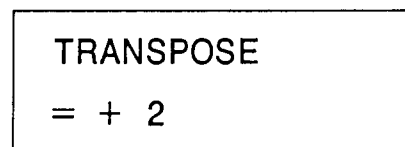
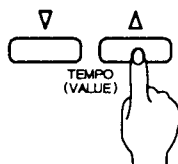

Since the pitch is adjusted in half-tone increments, moving to a value of +2 will transpose the piano up one full tone. In this instance, pressing the “C” key will play a “D” note. Pressing a C chord in Auto Orchestra will play a D chord. Settings can be adjusted from -12 to +12 on the display.

- Check the sound by playing the keys.
- The transpose mode will be cancelled if the TEMPO (VALUE) buttons are not pressed within several seconds.
- Transpose mode settings return to C when the power is turned off and then turned on again.

STEP 3 Press the TRANSPOSE button (or just wait for several seconds). The transpose settings will be entered and the screen will return to the normal display.



• The MIDI IN signal cannot be transposed.

13 STORING PANEL SETTINGS (REGISTRATION MEMORY)

Quickly changing sounds and rhythms during a performance is often difficult for even the most skilled player. "Registration Memory" allows you to store a selected combination of tones, rhythms and volume levels for immediate recall with the touch of a finger. A total of four "registrations" (complete panel settings) can be stored.

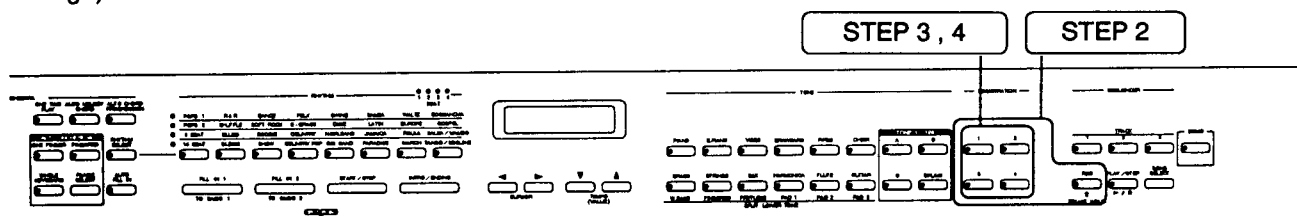

- STEP 1** Set the panel for the sound, rhythm and volume button settings, etc. that you desire. The data shown in the chart below is already stored in the registration memory. Registrations can also include for reverb types and transpose settings, etc.

The following items can be stored in the registration memory.

- **TONE**
Tone selection, DUAL settings, SPLIT settings and assignments of A, B, C and DRUMS button
- **RHYTHM**
Rhythm selection
Tempo
- **AUTO ORCHESTRA**
ONE FINGER button on/off, FINGERED button on/off, WHOLE KEYBOARD button on/off, volume control contents for rhythm, bass and chord part names, range select settings
- **ADDITIONAL**
SPLIT button on/off, REVERB button on/off, AUTO MELODY CHORD on/off, AUTO FILL-IN button on/off, REVERB type settings, TRANSPOSE settings, DUAL/SPLIT BALANCE settings, ALL GM ASSIGN on/off, ALL GM assign descriptions, SPLIT POINT settings

STEP 2

Press the desired registration button (REGISTRATION 1 - 4) while holding down the REC•REGIST WRITE button.

The panel settings will be stored and the display at right will be shown.

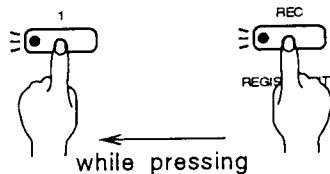

**REGIST.WRITE
COMPLETED!**

- During song mode (refer to p. 50) data cannot be stored in the registration memory.
- Data stored in registration memory will not be lost, even if the power is turned off.
- Reset when you wish to restore the settings preset at the factory. (Refer to p. 32)

To recall a registration stored in memory:

STEP 3

Press the desired registration button (REGISTRATION 1 - 4). The panel settings you stored earlier on that button will appear on the panel.



- When storing registrations, only numeric values will be stored. The actual position of the controls, buttons and levers will not change.
- After the registrations are recalled, the panel buttons and levers can be changed to adjust the registration.

STEP 4

To restore the panel to its original settings, press the registration button whose lamp is lit.

The registration button lamp that was lit will turn off, and the panel will return to the settings which were in effect before any registration buttons were pressed.



14 LISTENING TO THE DEMO SONG

This digital piano has been equipped with an impressive demo song to highlight the piano's considerable capabilities.

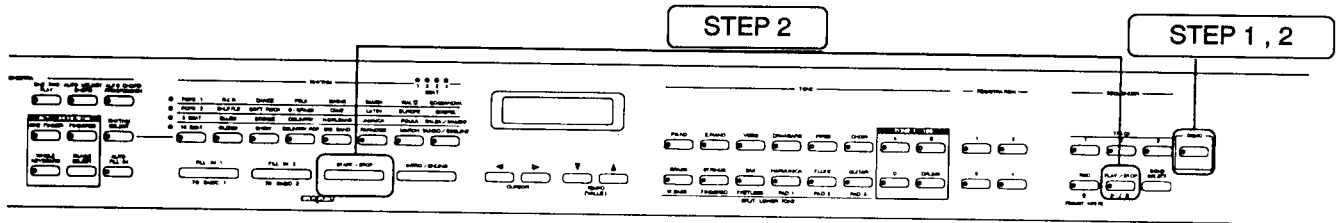

STEP 1 Press the DEMO button.
The demo song will begin.

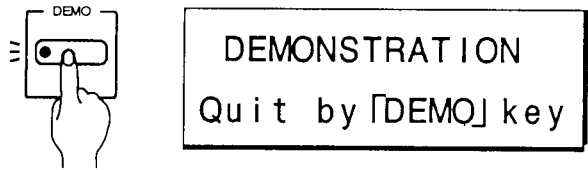

STEP 2 The demo song will stop when the DEMO button, the START/STOP button or the PLAY/STOP button are pressed.

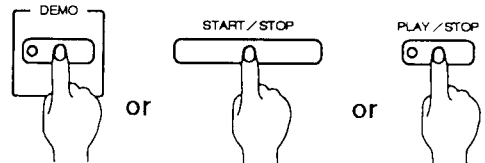

• During a demo song no sound will be heard from the keys when played.

15 RESET

When the RESET procedure is performed, all the settings for functions such as the recorder and registration memory are restored to the original factory settings.

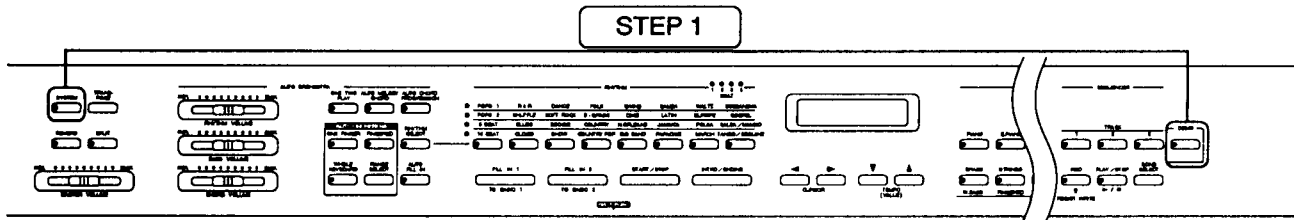

STEP 1

Press the DEMO button while holding down the SYSTEM button.

As shown in the display on the right, all settings will be restored to those in effect when the instrument was shipped from the factory.

After several seconds, the screen will return to the normal display.

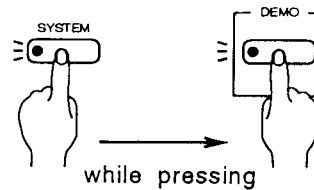

**FACTORY RESET
COMPLETED!**

- Reset is disabled in System Mode or while recording with the recorder.
- Performing the reset operation enables "GM Reset".
- Refer to p. 47 and p. 63 for details on factory settings.

16 SYSTEM SETTINGS

The System Mode allows various internal settings for this digital piano to be adjusted. In the system mode settings, system tuning data and data for sound designations stored in the memory will not be lost when ALL GM ASSIGN is ON, even if the power is turned off. Other settings, however, will be reset to factory settings (refer to p. 63), once the power is turned off.

1. TOUCH CURVE SETTINGS

This feature allows you to adjust the "Touch Response" of the key, ranging from a light touch to heavy touch. The physical touch of the keys will not change -- but the way the piano responds to your touch can be changed.

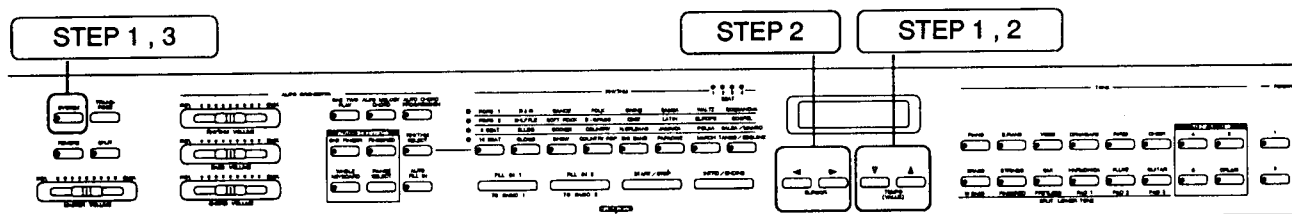

STEP 1 Press the **SYSTEM** button to enter the System Mode. Press the **TEMPO (VALUE)** button several times and select No.1 "TOUCH CURVE".

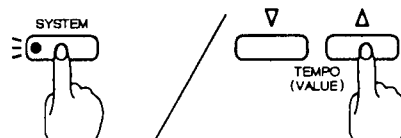

1 TOUCH CURVE
= NORMAL

STEP 2 Move the cursor as needed with the **CURSOR** button and press the **TEMPO (VALUE)** button several times to adjust the setting.

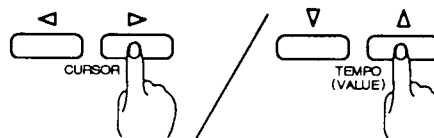

1 TOUCH CURVE
= NORMAL

SELECTION

- LIGHT 2.....This is a light touch curve, appropriate for children a light touch will produce louder volume.
- LIGHT 1.....This a fairly light touch curve.
- NORMALThis is the normal touch curve ... similar to an acoustic piano.
- HEAVY 1This a fairly heavy touch curve. Requires a heavier touch to produce loud volume.
- HEAVY 2This is a heavy touch curve. It requires a very strong touch to achieve loud volume.

STEP 3 Press the **SYSTEM** button once more and the lamp will turn off. The System Mode is now cancelled and the screen returns to the original display.



• MIDI keyboard data will not be output in System Mode.

2. LEFT PEDAL SETTINGS

This sets the left pedal function.

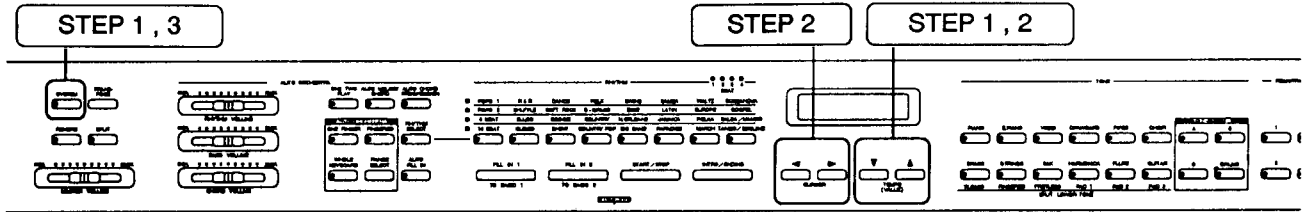

STEP 1 Press the SYSTEM button. To enter the System Mode. Press the TEMPO (VALUE) button several times to select No.2 "LEFT PEDAL".

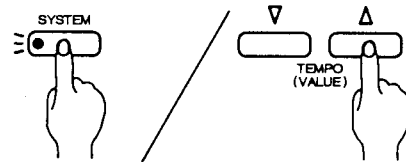

2 LEFT PEDAL
= SOFT

STEP 2 Move the cursor as needed with the CURSOR button and press the TEMPO (VALUE) button several times to adjust the left pedal setting.

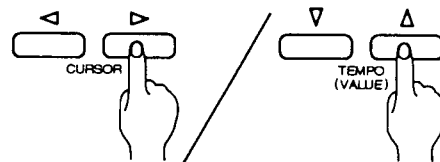

2 LEFT PEDAL
= SOFT

AVAILABLE SETTINGS:

- SOFT.....In this soft pedal mode, depressing the left pedal makes the sounds softer and the volume lower.
- START/STOP.....The start and stop of the rhythm can be controlled with the left pedal.
- INTRO/ENDING.....When the pedal is depressed while the rhythm is not currently playing, an intro pattern is played and the rhythm starts. When the pedal is depressed while the rhythm is playing, the rhythm will conclude after playing the ending pattern.
- FILL-IN1.....When the pedal is depressed while the rhythm is playing,
- FILL-IN2 a FILL-IN pattern is played.

STEP 3 Press the SYSTEM button once more and the lamp will turn off. The System Mode is now cancelled and the screen returns to the original display.



3. DAMPER PEDAL SETTINGS

This sets the damper (sustain) pedal function.

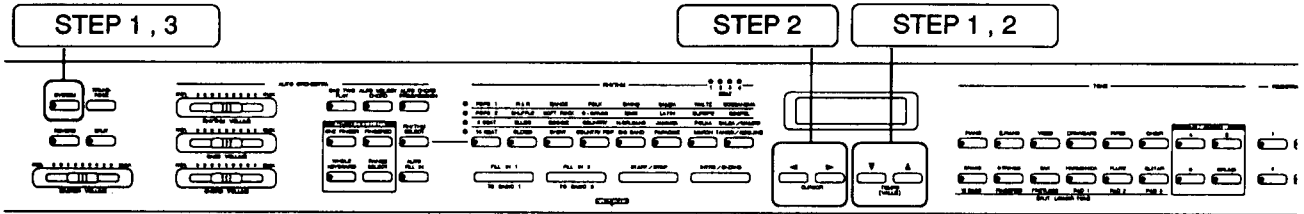

STEP 1 Press the SYSTEM button to enter the System Mode. Press the TEMPO (VALUE) button several times to select No.3 "DAMPER PEDAL".

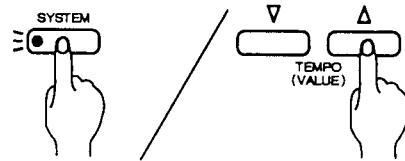

3 DAMPER PEDAL
= LOWER & UPPER

STEP 2 Move the cursor as needed with the CURSOR button and press the TEMPO (VALUE) button several times to adjust the damper pedal setting.

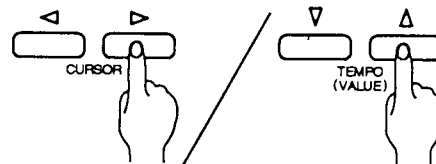

3 DAMPER PEDAL
= LOWER & UPPER

AVAILABLE SETTINGS

- LOWER & UPPER
This applies the damper (sustain) effect to both upper and lower keyboards during SPLIT.
- LOWER
This applies the damper effect to the lower keyboard only during SPLIT.
- UPPER
This applies the damper effect to the upper keyboard only during SPLIT.

STEP 3 Press the SYSTEM button once more and the lamp will turn off. The System Mode is now cancelled and the screen returns to the original display.



4. DUAL/SPLIT BALANCE SETTINGS

This adjusts the volume balance between sounds when the DUAL and SPLIT functions are activated.

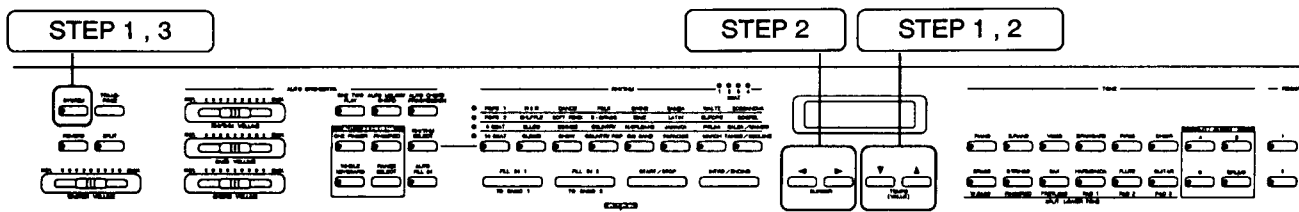

- STEP 1** Press the SYSTEM button to enter the System Mode.
Press the TEMPO (VALUE) button to select No.4 "DUAL & SPLIT".

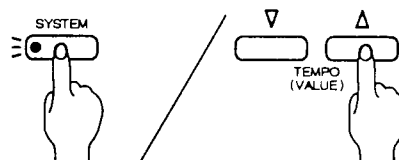

4 DUAL & SPLIT
BALANCE=100:100

- STEP 2** Move the cursor as needed with the CURSOR button and press the TEMPO (VALUE) button several times to adjust the DUAL & SPLIT setting.

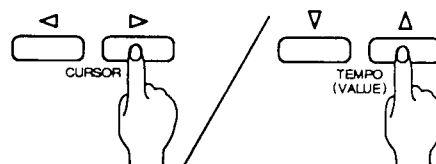

AVAILABLE SETTINGS:

100 ↑ large volume
↓
1 ↓ small volume

4 DUAL & SPLIT
BALANCE=^(a)100_(b):100

↑ cursor shifts

- For DUAL
 - (a) : Sound volume for right side or lower side panel sound buttons
 - (b) : Sound volume for left side or upper side panel sound buttons
- For SPLIT
 - (b) : Upper keyboard volume
 - (a) : Lower keyboard volume

- Values can change in range from 1 - 100.
- When the master volume control is set to a low level, the overall volume will not increase even when each individual volume control is operated.

- STEP 3** Press the SYSTEM button once more and the lamp will turn off. The System Mode is now cancelled and the screen returns to the original display.



5. SPLIT POINT SETTINGS

This allows you to adjust the location of the SPLIT POINT.

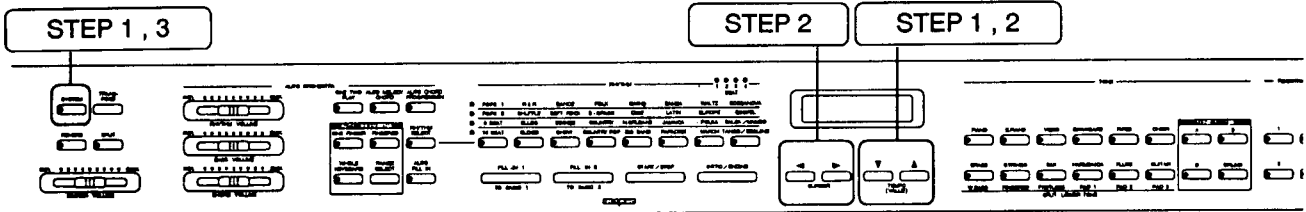

STEP 1 Press the **SYSTEM** button to enter the System Mode. Press the **TEMPO (VALUE)** button several times to select No.5 "SPLIT POINT".

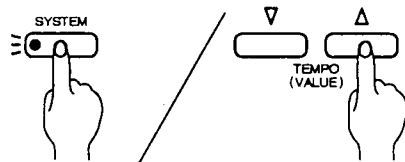

STEP 2 Move the cursor as needed with the **CURSOR** button and press the **TEMPO (VALUE)** button several times to adjust the SPLIT POINT setting.

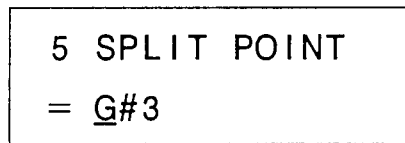
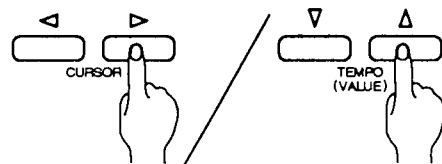

AVAILABLE SETTINGS: A₀ - C₈
(KSP5: E₁~G₇)

Note(KSP10):

The subscript number identifies the octave in which the note appears. The "0" subscript refers to the partial octave at the left end of the keyboard. "C₁" is the first C to appear (from the left) in the first full octave on the piano keyboard.

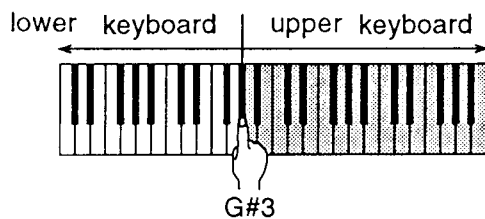

You can also press the key that you want as the SPLIT POINT.

That key will appear in the display and will become the lowest note of the upper keyboard.

STEP 3 Press the **SYSTEM** button once more and the lamp will turn off. The System Mode is now cancelled and the screen returns to the original display.



6. REVERB DEPTH SETTINGS

This allows you to set the depth of the reverb effect as needed.

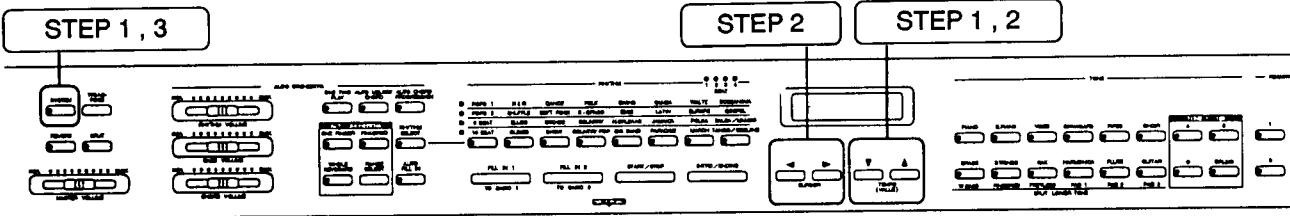

STEP 1 Press the SYSTEM button to enter the System Mode. Press the TEMPO (VALUE) button several times to select No.6 "Rev.DEPTH SET".

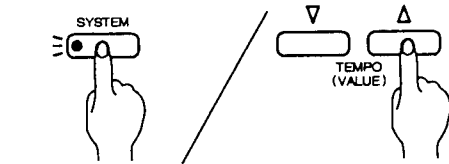

6 Rev .DEPTH SET
HI= 7 LO= 1

STEP 2 Move the cursor as needed with the CURSOR button and press the TEMPO (VALUE) button several times to adjust the reverb depth setting.

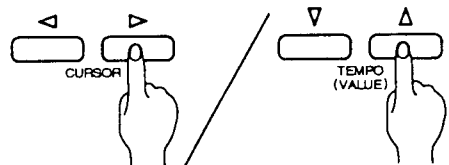

6 Rev .DEPTH SET
HI= 7 LO= 1

↕
cursor shifts

In this mode, you can set two types of reverb depth value (HI and LO). The HI and LO value that you set here will be used with the "PART REVERB DEPTH" setting as the next page.

AVAILABLE SETTINGS:
10 ↑ Deeper reverb is applied.
↓
1 ↓ Shallower reverb is applied.

HIHigh
LOLow

The settings for HI and LO are all compatible with the reverb types (refer to p. 13).

STEP 3 Press the SYSTEM button once more and the lamp will turn off. The System Mode is now cancelled and the screen returns to the original display.



7. PART REVERB DEPTH SETTINGS

This allows reverb depth settings to be customized for separate accompaniment and performance parts.

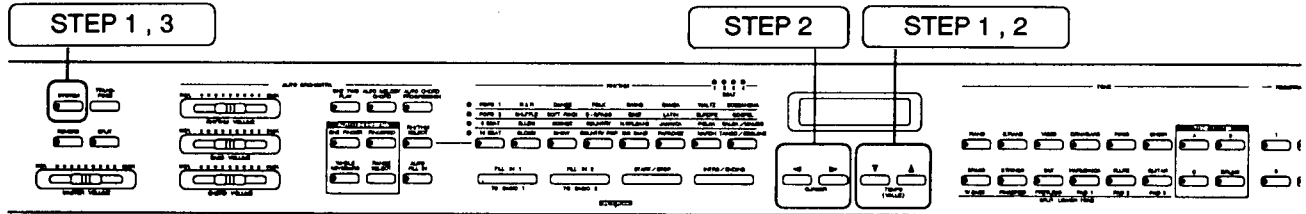

STEP 1 Press the SYSTEM button to enter the System Mode. Press the TEMPO (VALUE) button several times to select No.7 "PART".

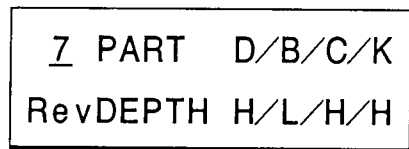
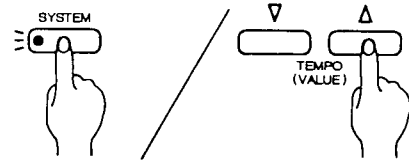

STEP 2 Move the cursor as needed with the CURSOR button and press the TEMPO (VALUE) button several times to adjust the setting.

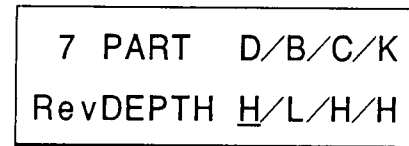
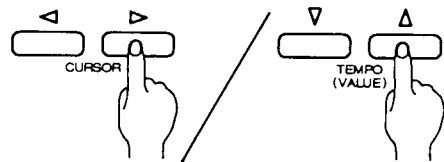

↑↑↑↑ cursor shifts

The HI and LO settings specified on the previous page are assigned to respective accompaniment and performance parts:

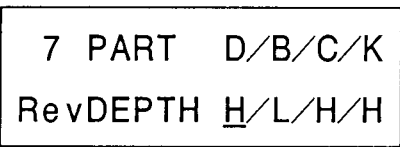

- DAuto accompaniment drum/percussion parts
 - BAuto accompaniment bass parts
 - CAuto accompaniment chord parts
 - KPerformance parts with keys
- Settings HHI (High)
LLO (Low)

For instance, if you set HI=7 and LO=1 as described on the previous page, the following reverb settings are specified as seen in the display above.

PART	SETTING	
D (drum/percussion)	H	Reverb of depth 7 applied
B (bass)	L	Reverb of depth 1 applied
C (chord)	H	Reverb of depth 7 applied
K (keyboard sound)	H	Reverb of depth 7 applied

STEP3 Press the SYSTEM button once more and the lamp will turn off. The System Mode is now cancelled and the screen returns to the original display.



8. LOCAL CONTROL SETTINGS

This allows you to change the Local Control setting. "Local Control" determines whether or not a sound is heard when a key is pressed. Normally Local Control will be "ON" and you will hear sound when you press keys on the piano. When using this digital piano as a MIDI controller, you may want to turn off the sound on all or part of the keyboard. This would allow you to hear only the sound produced by an external keyboard or module that you are controlling via MIDI.

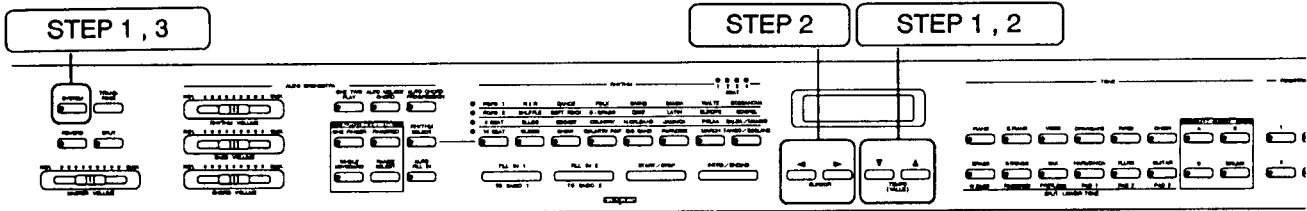

STEP 1 Press the SYSTEM button to enter the System Mode.
Press the TEMPO (VALUE) button several times to select No.8 "LOCAL".

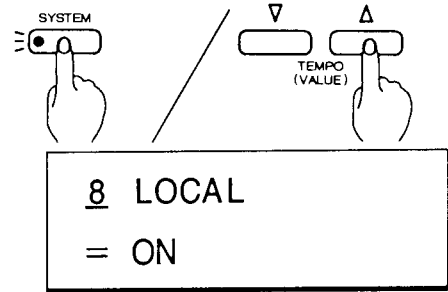

STEP 2 Move the cursor as needed with the CURSOR button and press the TEMPO (VALUE) button several times to change the "Local" setting.

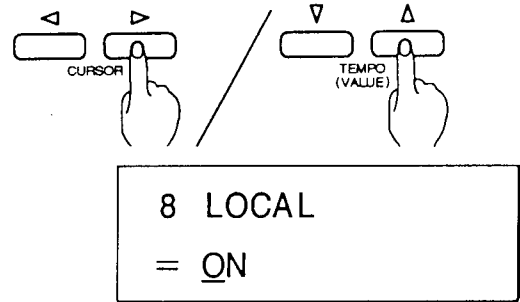

AVAILABLE SETTINGS

- ONSound is heard when keys are played and also when MIDI data is received.
- OFFNo sound is heard when keys are played. Sound is heard only when MIDI data is received.
- UPPER OFF.....Lower keyboard is ON and upper keyboard is OFF.
This is convenient when using Auto Orchestra on the lower keyboard while playing right hand melodies on the upper keyboard which are to be heard on another sound source (keyboard or module) that is controlled through MIDI.

STEP 3 Press the SYSTEM button once more and the lamp will turn off. The System Mode is now cancelled and the screen returns to the original display.



9. SYSTEM TUNING SETTINGS

This allows you to "fine tune" the pitch of this digital piano to adjust easily to the pitch of other instruments.

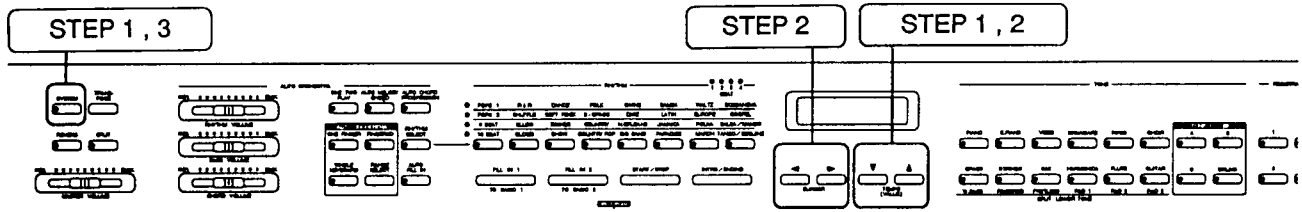

STEP 1 Press the SYSTEM button to the System Mode. Press the TEMPO (VALUE) button several times to select No.9 "SYSTEM TUNE".

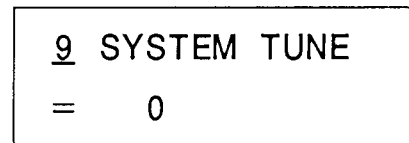
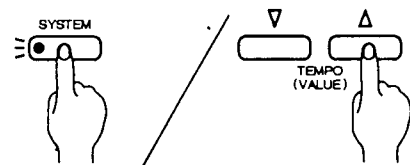

STEP 2 Move the cursor as needed with the CURSOR button and press the TEMPO (VALUE) button several times to adjust the system tune setting.

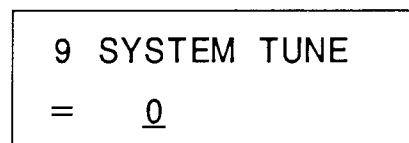
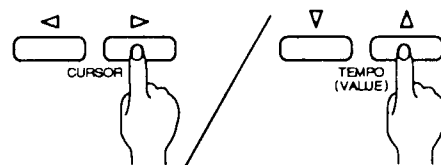

- The system tune setting can range from -32 to +32.
[± 50 cents (100 cents = a half tone)]

The system tune setting will not change even when the power is turned off.

STEP 3 Press the SYSTEM button once more and the lamp will turn off. The System Mode is now cancelled and the screen returns to the original display.



10. TEMPERAMENT SETTINGS

The sounds on this digital piano can also be played with various temperaments.

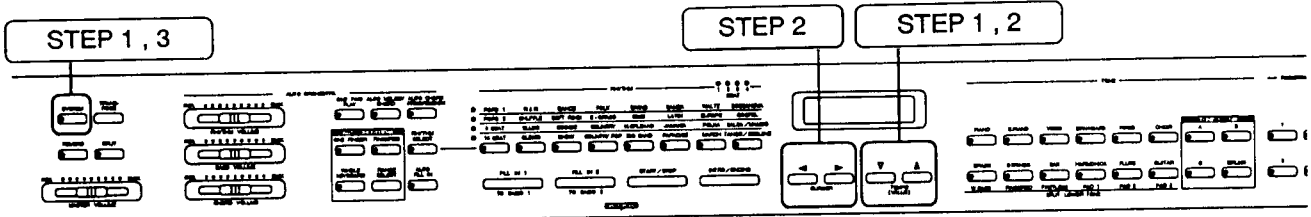

STEP 1

Press the SYSTEM button to enter the System Mode. Press the TEMPO (VALUE) button several times to select No.10 "TEMPERAMENT".

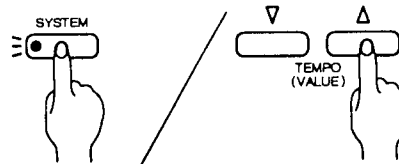

10 TEMPERAMENT
TYPE=1 KEY=C

STEP 2

Move the cursor as needed with the CURSOR button and press the TEMPO (VALUE) button several times to change the temperament setting.

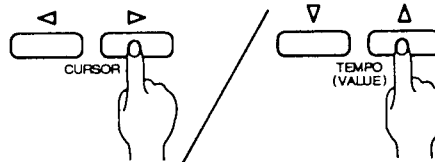

10 TEMPERAMENT
TYPE=1 KEY=C

↑ cursor shifts

Setting		Temperament Characteristics
TYPE 1	Equal Temperament	One of the most popular piano tuning methods. Chords sound the same (and maintain the same relative consonance) in any key.
TYPE 2	Mersenne Temperament	Still widely used for choral music. Consonances for thirds and fifths are removed.
TYPE 3	Pythagorean Temperament	This tuning method uses mathematical ratios to eliminate consonances for fifths. It has problems with chords, but produced beautiful melodic lines.
TYPE 4	Meantone Temperament	This tuning method in which the third consonance is removed has improved on the Mersenne temperament, which had a little unharmonious fifth consonance, and produces chords that are more beautiful than those using equal temperament.
TYPE 5	Werckmeister III Temperament	These methods offer beautiful sounding chords similar to those of the mean tone for key signatures with few accidentals. As the accidentals increase, the tension grows higher, and the temperament produces beautiful melodies closer to those in the Pythagorean temperament. These types are primarily used by classical music composers who want to take advantage of these characteristics.
TYPE 6	Kirnberger III Temperament	

The key setting for the temperament is done at the KEY position on the display from C through B.

STEP 3

Press the SYSTEM button once more and the lamp will turn off. The System Mode is now cancelled and the screen returns to the original display.



11. ALL GM ASSIGNMENT SETTINGS

The buttons in the figure below can be used to store your favorite choices from among the 128 sounds, just as you did with the A, B, C buttons.

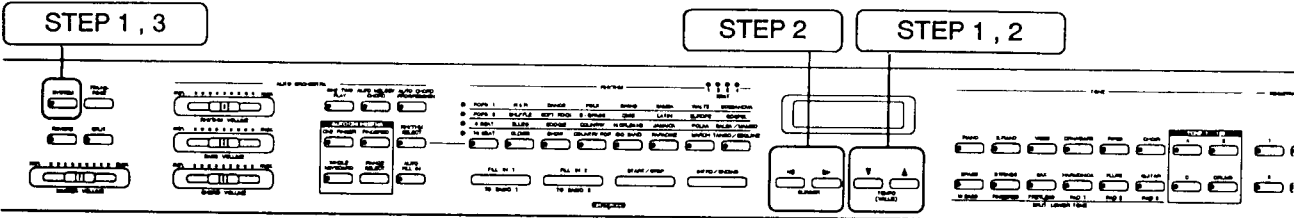
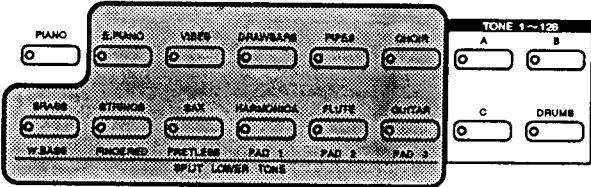

STEP 1 Press the SYSTEM button to enter the System Mode. Press the TEMPO (VALUE) button several times to select No.11 "ALL GM ASSIGN".

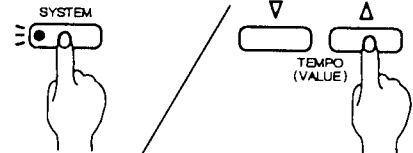

11 ALL GM ASSIGN
= OFF

STEP 2 Move the cursor as needed with the CURSOR button and press the TEMPO (VALUE) button several times to adjust the setting.

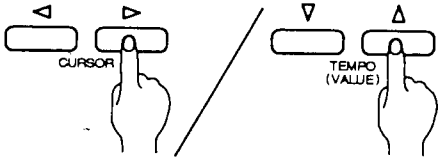

11 ALL GM ASSIGN
= OFF

- AVAILABLE SETTINGS**
- OFF.....Normal status
 - ON.....You can assign your favorite sounds to the 11 sound buttons.

STEP 3 Press the SYSTEM button once more and the lamp will turn off. The System Mode is now cancelled and the screen returns to the original display.



• After turning the above setting ON and returning to the previous screen, use the procedures described in [STEP3 - STEP4] on page 7 to assign the desired sounds to the 11 sound buttons. The sound assignment settings, regardless of the OFF/ON setting, are stored in memory and will not be lost, even if the power is turned off.

12. SYSTEM CHANNEL SETTINGS

This page describes how to set the MIDI channel for controlling the flow of musical data to and from other instruments via MIDI.

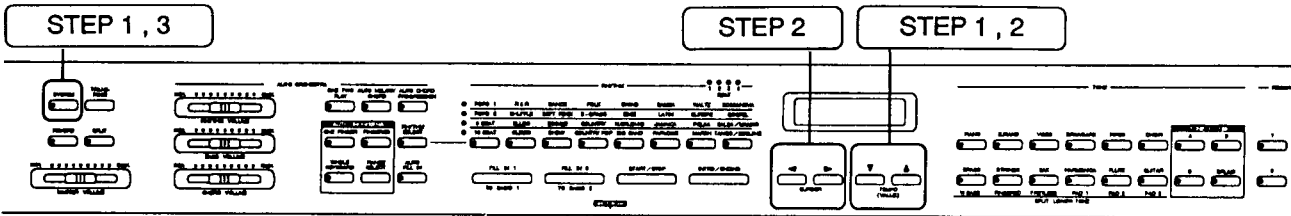

STEP 1

Press the SYSTEM button to enter the System Mode. Press the TEMPO (VALUE) button several times to select No.12 "SYSTEM CH".

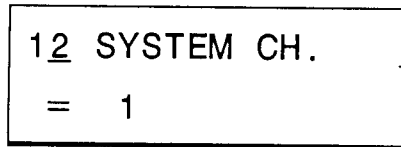
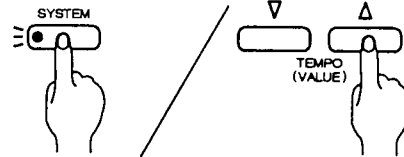

STEP 2

Move the cursor as needed with the CURSOR button and press the TEMPO (VALUE) button several times to change the setting.

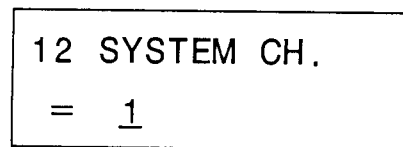
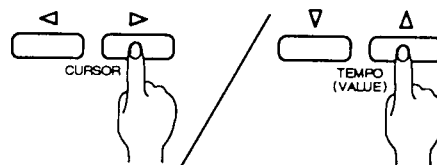

The system channel setting can range from 1 - 16 (channels).

Refer to p. 59 for details on MIDI connections.

STEP 3

Press the SYSTEM button once more and the lamp will turn off. The System Mode is now cancelled and the screen returns to the original display.



13. MIDI CLOCK SETTINGS

Determines whether or not the rhythm will start when a MIDI signal is received.

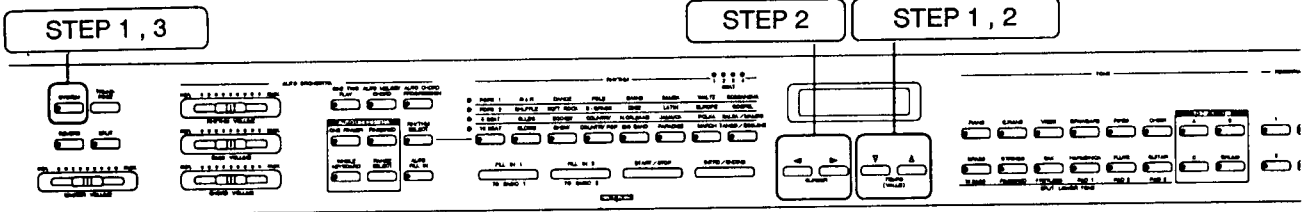

STEP 1 Press the **SYSTEM** button to enter the System Mode.
Press the **TEMPO (VALUE)** button several times to select No.13 "MIDI CLOCK".

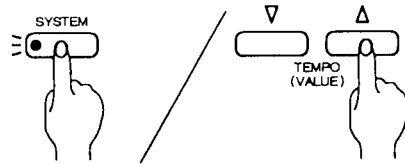

STEP 2 Move the cursor as needed with the **CURSOR** button and press the **TEMPO (VALUE)** button several times to change the setting.

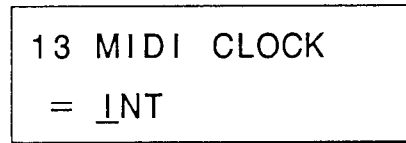
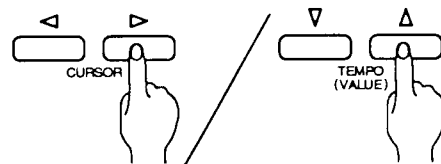
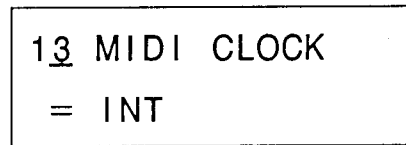

- INTWill not receive external MIDI CLOCK and START signals.
- EXTWill receive external MIDI CLOCK and START signals.

STEP 3 Press the **SYSTEM** button once more and the lamp will turn off. The System Mode is now cancelled and the screen returns to the original display.



Please note the following when set to EXT.

- The rhythm/Auto Orchestra/recorder cannot be started with the panel switches on the piano. They can only be started with the MIDI CLOCK and START signals. Once started in this way, the accompaniment can be stopped with FILL-IN 1 and 2, START/STOP and INTRO/ENDING patterns.
- The recorder can be played right after entering song mode (refer to p. 50) when the start signal is received.
- When the start signal is received during record standby (refer to p. 51), recording can be started.

14. MULTI-TIMBRE SETTINGS

This function determines whether your digital piano will receive MIDI data on one MIDI channel (the SYSTEM CHANNEL) or on all channels (1-16) simultaneously.

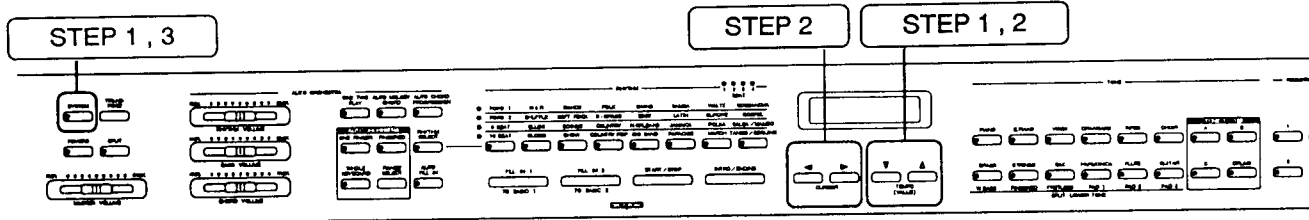

STEP 1 Press the SYSTEM button to enter the System Mode. Press the TEMPO (VALUE) button several times to select No.14 "MULTI-TIMBRE".

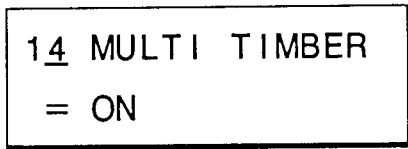
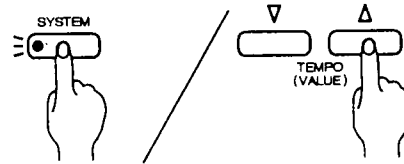

STEP 2 Move the cursor as needed with the CURSOR button and press the TEMPO (VALUE) button several times to change the setting.

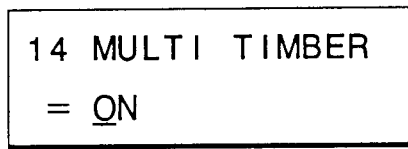
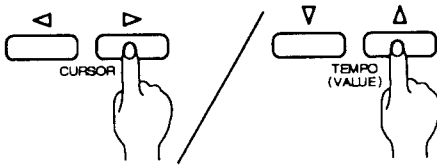

- ONSeparate sounds can be played through MIDI on any of the MIDI channels from 1-16.
- OFFSounds selected on the panel can be played through MIDI (refer to p. 44) using only the channel set earlier as the "SYSTEM CHANNEL".

STEP 3 Press the SYSTEM button once more and the lamp will turn off. The System Mode is now cancelled and the screen returns to the original display.



When MULTI TIMBRE is set to ON, this digital piano can be used as a 16-section MULTI TIMBRE GM (General MIDI) sound source.

Factory settings for MULTI TIMBRE ON (when the unit has been reset).

MIDI receive section	MIDI receive channel	Sound	Reverb HI/LO
1	1	001 Gr Piano	HI
2	2	001 Gr Piano	HI
3	3	001 Gr Piano	LO
4	4	001 Gr Piano	HI
5	5	001 Gr Piano	HI
6	6	001 Gr Piano	HI
7	7	001 Gr Piano	HI
8	8	001 Gr Piano	HI
9	9	001 Gr Piano	HI
10	10	DR1 STANDARD	HI
11	11	001 Gr Piano	HI
12	12	001 Gr Piano	HI
13	13	001 Gr Piano	HI
14	14	001 Gr Piano	HI
15	15	001 Gr Piano	HI
16	16	001 Gr Piano	HI

Settings which can be changed on the piano:

- ON/OFF to determine whether or not sound will be heard from each channel (Refer to p. 48)
- Reverb type (compatible with all sections) (Refer to p. 14)
- Level settings for reverb depth HI and LO (compatible with all sections) (Refer to p. 38)
- Tuning settings (compatible with all sections) (Refer to p. 41)
- Temperament settings (compatible with all sections) (Refer to p. 42)

- Selections such as “the sound of each section” and the “reverb HI and LO” can be changed with MIDI program change information and MIDI control data.
- Performing the reset operation (refer to p. 32) enables “GM Reset” for each section.

Settings for MULTI TIMBRE OFF

- MIDI receive channel (Refer to p. 44)
 - Reverb type (Refer to p. 14)
 - Reverb depth (Refer to p. 38)
 - Tune (Refer to p. 41)
 - Temperament settings (Refer to p. 42)
 - Sound Expresses sounds chosen on the piano.
- Settings are changed on the digital piano.

15. SECTION MUTE SETTINGS

This function determines the non-receiving MIDI channels for MIDI operation when the MULTI TIMBRE setting is ON. This function is disabled when the MULTI TIMBRE setting is OFF.

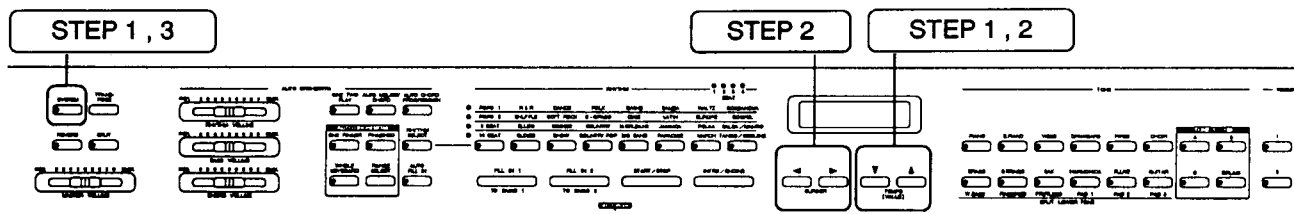

STEP 1 Press the SYSTEM button to enter the System Mode. Press the TEMPO (VALUE) button several times to select No.15 "SECTION MUTE".

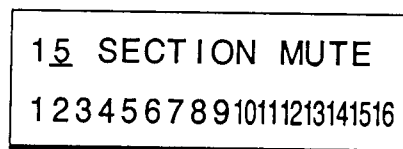
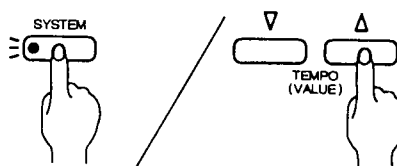

STEP 2 Move the cursor as needed with the CURSOR button and press the TEMPO (VALUE) button several times to adjust the section mute setting.

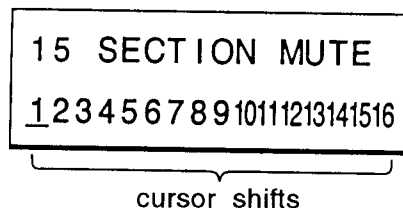
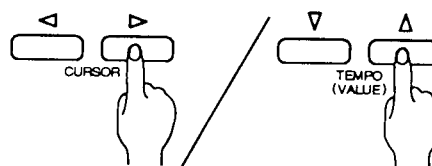

Change the numbers on the lower row of the display, for instance, to 1↔*.

For example, when you do not want to receive MIDI signals on channels 3, 8 and 14, adjust the settings as shown in the figure on the right.

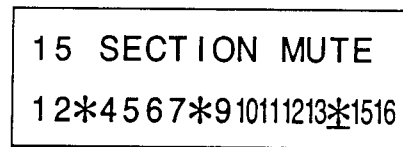

STEP 3 Press the SYSTEM button once more and the lamp will turn off. The System Mode is now cancelled and the screen returns to the original display.



• During System Mode, sounds will not be played even if a MIDI signal is received.

17 USING THE RECORDER

The recorder function in your digital piano allows you to record and play back any performance. You could record an Auto Orchestra background and then replay it while recording a right-hand melody. You can also record the left and right hand parts of a difficult song separately and then play them back at the same time. Once a song is recorded, it will remain in memory even if the power is turned off. The recorder can record a maximum of ten songs, with three tracks provided for each song.

SONG 1	1 TRACK
	2 TRACK
	3 TRACK

Separate parts can be recorded on each track.

SONG 2	1 TRACK
	2 TRACK
	3 TRACK

Track 1 is the main track. Use this track for all one-track recording.

SONG 3	1 TRACK
	2 TRACK
	3 TRACK

Tracks 2 and 3 are “subtracks” used for overdubbing. You can record additional parts on these tracks while listening to the music you recorded on Track 1.

Left-hand parts recorded on Track 1 and right-hand parts recorded on Track 2 can be played back together, even though they were recorded separately.

A track is a place for separate recording of different parts.

TRACK 1
Record an Auto
Orchestra part.



TRACK 2
Record a melody
part.

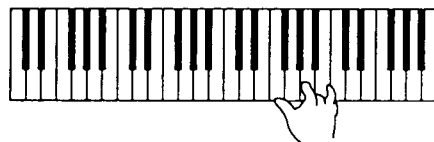

When you play back



you get an Auto Orchestra + melody.

You can also record different sounds on each track and create an “ensemble” performance.

Track 1	Auto Orchestra
Track 2	Piano
Track 3	Organ

Now try making an actual recording.

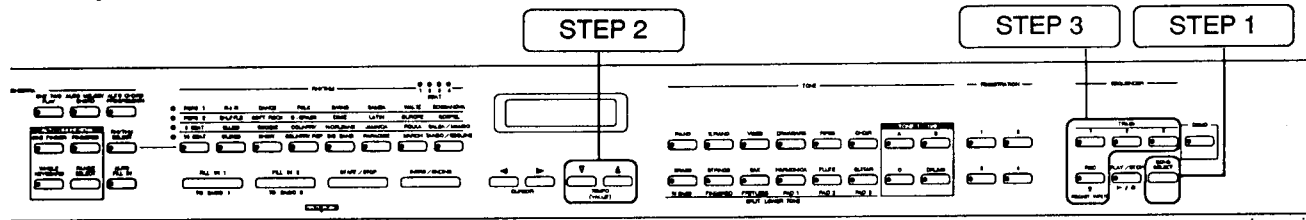

STEP 1 Press the SONG SELECT button and song mode will be selected.



In song mode, the song number is displayed on the upper row of the screen.

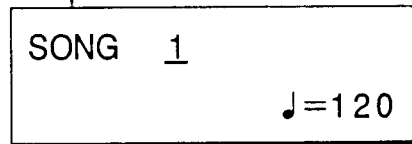

CAUTION

Song mode is selected when using the recorder. Pressing the SONG SELECT button lets you switch between normal mode and song mode. MIDI signals cannot be received in song mode. (Refer to p. 59)



The mode (display) is changed each time you press the button.

Normal display

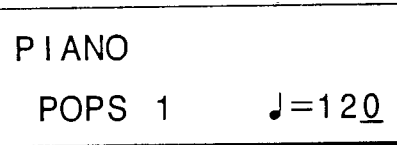

Song mode display

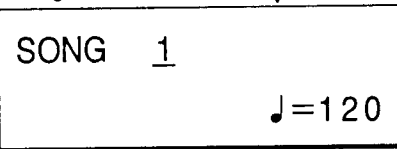

STEP 2 Press the TEMPO (VALUE) button and select the song No.(1-10) that you want to record.

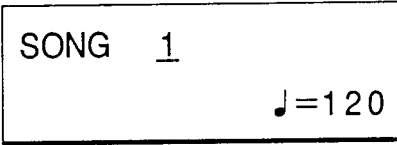
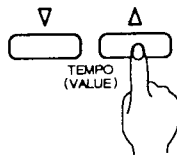

STEP 3 Press the TRACK 1 button while holding down the REC button.

while pressing

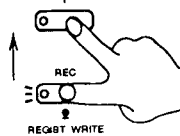

Track1 is selected.

The display at the right is shown while the REC button is held down.

The remaining space in the recorder memory is displayed.

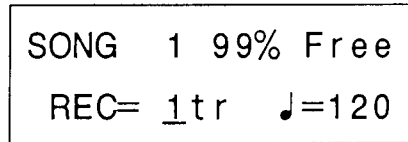

When you release your finger from the REC button, a metronome begins to "tick" and the display at the right is shown.

The tempo can be changed with the TEMPO (VALUE) button.

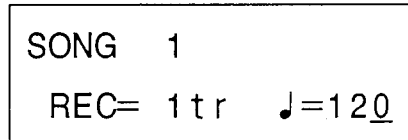

- The metronome volume is adjusted with the rhythm volume (Refer to p. 21).
- The multi timbre setting will be "on" during song mode (Refer to p.46).

You are now ready to record. (Record standby)
 Pressing the REC button will cancel the record standby condition.

When the track you selected is already fully recorded, the display at the right can be seen.
 Please note that if you start recording on a fully recorded track, the previous data will be erased!

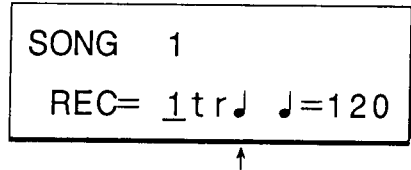

STEP 4, 6

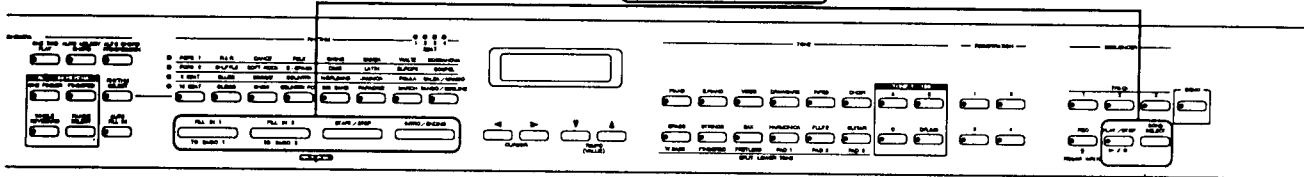

STEP 4

- Start recording, using one of the following 3 methods.
- Play a keyRecording starts automatically when you play a key (when Auto Orchestra is OFF). This "AUTO START" feature is convenient for recording songs without the Auto Orchestra function.
 - Press the PLAY/STOP buttonRecording will start. This is useful when you want to insert a few moments of silence before starting to play.
 - Start the rhythmRecording of rhythm/Auto Orchestra starts immediately when you start the rhythm or Auto Orchestra.

Rhythm cannot be started while recording.

STEP 5

During recording, the current bar (measure) is displayed.

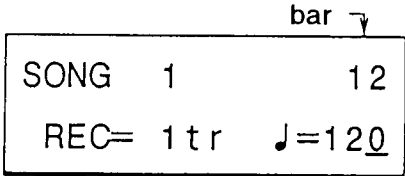

Important Recording Notes:

- Sound, rhythm and tempo can be changed while recording.
- During rhythm play, DRUMS and other sounds cannot be changed.
- Rhythm, Auto Orchestra and Auto Chord Progression can only be recorded on Track 1.
- DUAL and SPLIT sounds • Auto Melody Chord can only be recorded on Track 1.

To stop recording, press the PLAY/STOP button or the START/STOP button.

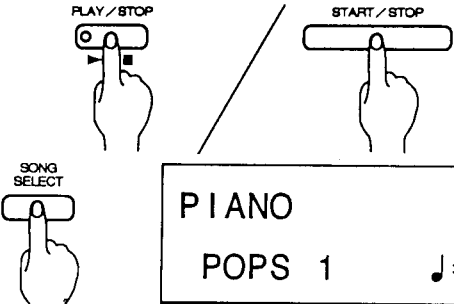

STEP 6

Press the SONG SELECT button. This exits the song mode and the screen returns to the original display.

• During record and record standby, the following button functions are disabled:
 →Changing the sound contents of AUTO CHORD PROGRESSION, A, B, C, and DRUM buttons, DEMO performance and SYSTEM buttons

USING THE RECORDER — PLAYBACK

The song you recorded can now be played back.

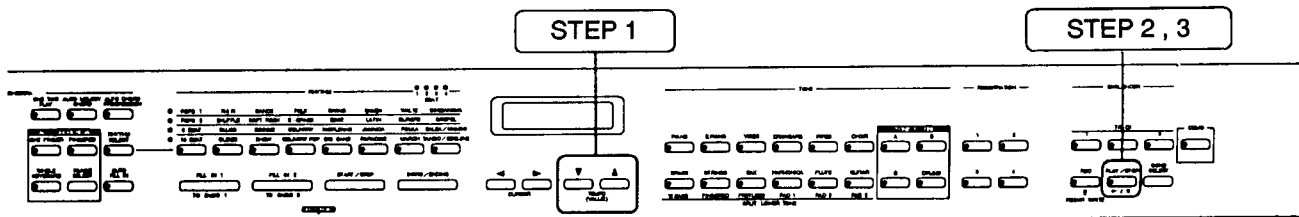

STEP 1

Press the SONG SELECT button to enter Song Mode.

Press the TEMPO (VALUE) button (refer to p. 50) to select a song number (1-10).

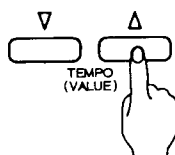

SONG 1
♩=120

STEP 2

Press the PLAY/STOP button to start playback.

The current measure is displayed on the screen. Your song is played back with the sounds used during recording.

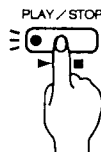

SONG 1 bar 12
♩=120

STEP 3

Press the PLAY/STOP button. The button's lamp will turn off and playback will stop.



During playback of a song, Auto Orchestra data is sent through MIDI (refer to p. 61).

RECORDING SOUNDS ON MULTIPLE TRACKS

To try the overdubbing feature, record an Auto Orchestra on Track 1 and then listen to it while recording a melody on Track 2.

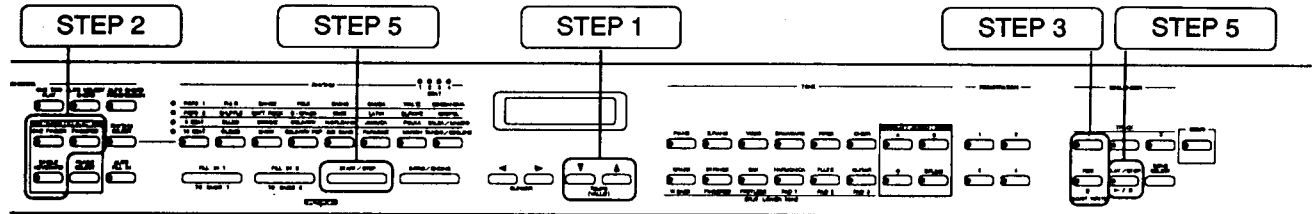

STEP 1 Press the TEMPO (VALUE) button in song mode (Refer to p. 50) and select a song (No. 1-10).

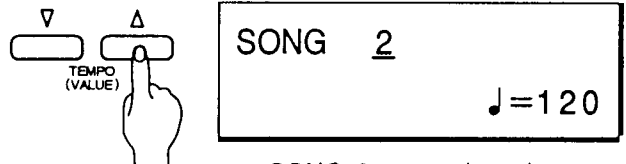

STEP 2 Select a rhythm and press one of the Auto Orchestra buttons.

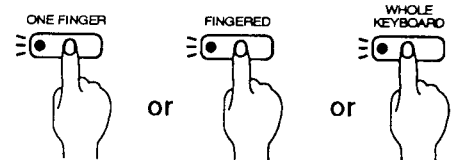

STEP 3 Press the TRACK 1 button while holding down the REC button. (Record standby)

while pressing ↑

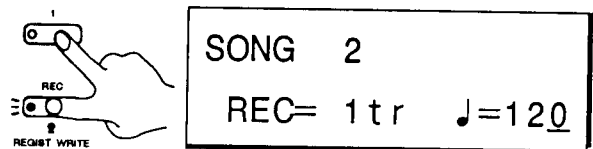

STEP 4 Hold down a chord and start Auto Orchestra. (Refer to p. 17) You can also start with an INTRO. (Refer to p. 20)

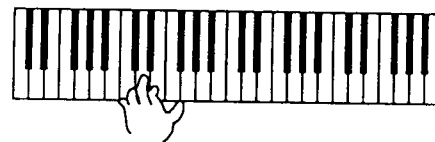

Recording starts simultaneously with the start of Auto Orchestra.

bar progression ↓

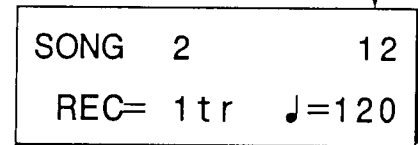

STEP 5 When you are finished, press the START/STOP button or PLAY/STOP button. The Auto Orchestra and recording function will stop.

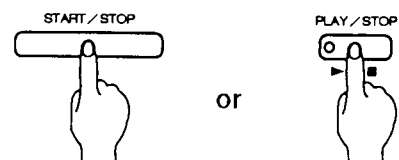

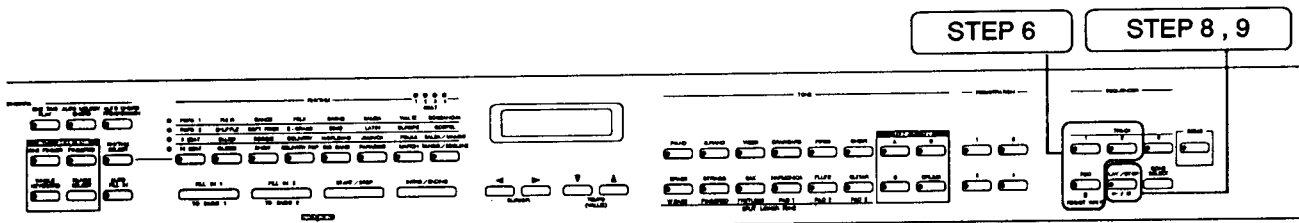

STEP 6 Next, record a melody on TRACK 2 while listening to the Auto Orchestra track recorded on Track 1.

while pressing

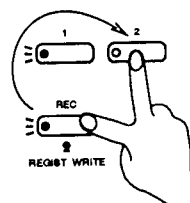

SONG	2
REC=	2tr ♩=120

Press the TRACK 2 button while holding down the REC button.
(Record standby)

STEP 7 Press the PLAY/STOP button.

The Auto Orchestra part that you recorded will play back.

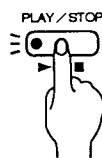

	bar progression
SONG	2 12
REC=	2tr ♩=120

STEP 8 Play a melody in time with the Auto Orchestra.

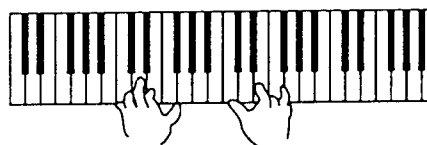

STEP 9 When your performance is finished, press the PLAY/STOP button and the recording function will end.



Pressing the SONG SELECT button exits song mode and returns the piano to normal status.

Recordings can also be added to Track 3 in the same way. Repeat steps 6-9 using the Track 3 button.

RECORDING AUTO CHORD PROGRESSIONS

Auto Chord Progressions can also be recorded on Track 1, just as you did with Auto Orchestra.

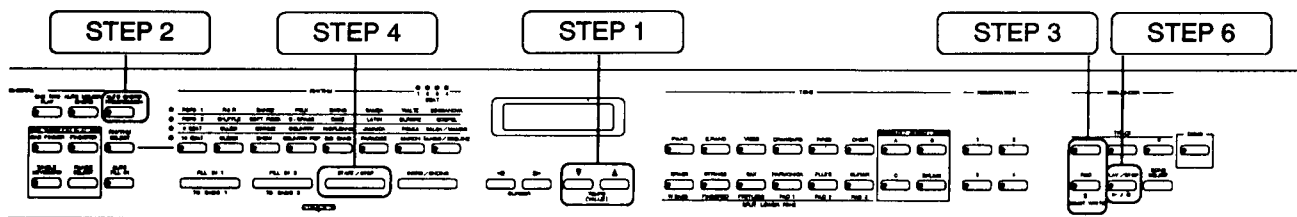

STEP 1 Press the TEMPO (VALUE) button in song mode (Refer to p. 50) and select a song (No. 1-10).

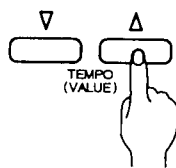

SONG 3
♩=120

In this case SONG 3 was selected.

STEP 2 Select a rhythm and press the AUTO CHORD PROGRESSION button.

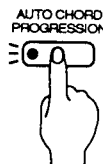

SONG 3
PRG01 C ♩=122

In this case POPS1 was selected.

STEP 3 Press the TRACK1 button while holding down the REC button. (Record standby)

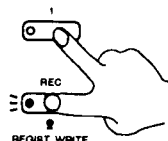

SONG 3
REC= 1tr ♩=122

STEP 4 Press the START/STOP button.

Recording starts simultaneously with the start of auto chord progression.

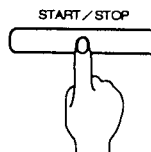

current bar number ↓
SONG 3 12
REC= 1tr ♩=122

Note

At such times, the bar number shown in the display will differ from the bar number on the Auto Chord Progression Chart.

STEP 5 Play a melody in time with the accompaniment.

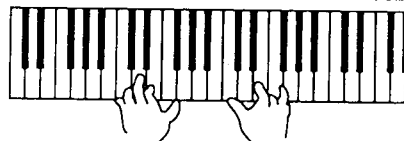

STEP 6 Press the START/STOP button or PLAY/STOP button and the accompaniment and recording will stop.

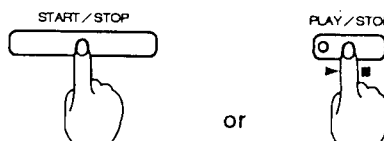

Pressing the SONG SELECT button exits song mode and returns the piano to normal status.

A recorded melody can be added to Tracks 2 and 3, as described on p. 53 - 54.

USING THE RECORDER — TRACK BUTTON ON/OFF

You can turn a particular track "off" to keep it from being erased (with an overdub track) or to keep it from playing back with other tracks.

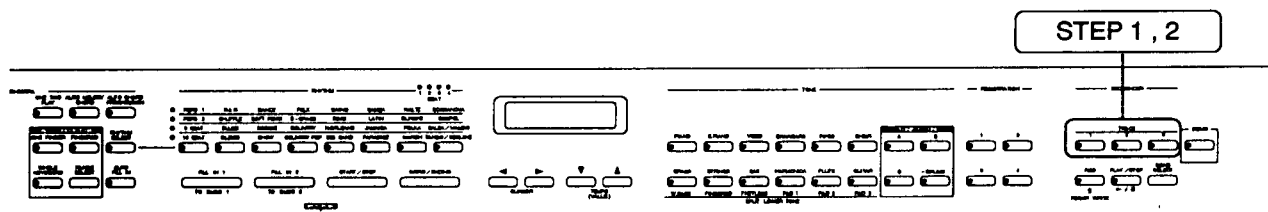

STEP 1 Press the desired TRACK button. The track button's lamp will turn off and that track cannot be played back (or recorded upon).

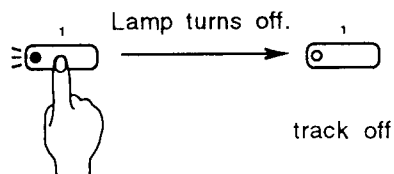

STEP 2 Press that TRACK button again to let the track play back again. The track button's lamp will light.

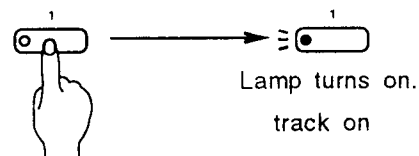

- Delete the track contents when you want to erase all data on a track. (Refer to the next page.)
- The track button cannot be switched on and off during record or record standby.

USING THE RECORDER — DELETING TRACK DATA

The contents of any track can be deleted with the following procedure:

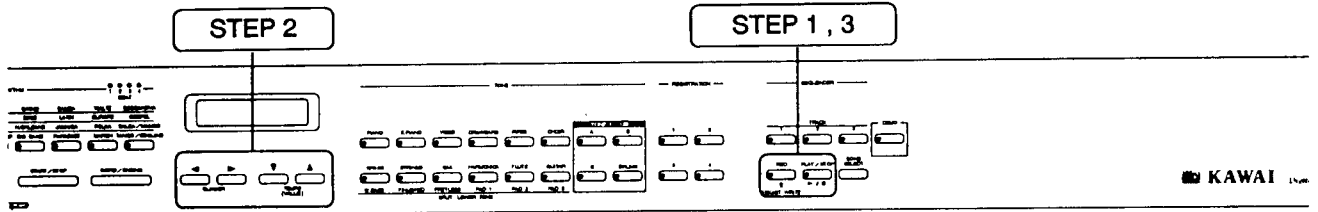

STEP 1 Press the PLAY/STOP button while holding down the REC button in song mode. (Refer to p. 50)

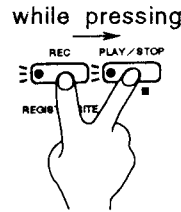

TRACK DELETE
SONG=1 Tr=CANCEL

STEP 2 Move the cursor as needed with the CURSOR button and press the TEMPO (VALUE) button to select the desired song No. and track No.

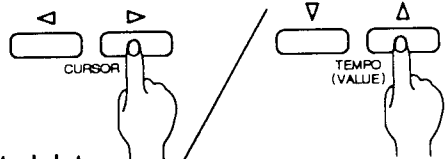

1	CANCELwill not delete
SONG =2	TRACK = 1Track 1
3 (Tr)	2Track 2
⋮	3Track 3
10	ALLAll tracks

Example 1 : For deleting only Track 1 of SONG 1.

TRACK DELETE
SONG=1 Tr=1

Example 2 : For deleting all tracks of SONG 2.

TRACK DELETE
SONG=2 Tr=ALL

Example 3 : For stopping the delete function.

TRACK DELETE
SONG=1 Tr=CANCEL

STEP 3 Press the PLAY/STOP button when the procedure has been completed.

The contents of the track that you specified has been deleted.

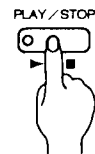

The track will not be cancelled when the setting is Tr = CANCEL.

• During [STEP2] the deletion will be stopped and the screen returns to the last previous display, even if the REC button is pressed.

RECORDER PRECAUTIONS

- When the recorder memory is full during (or prior to) recording, an error message will appear on the screen and recording will stop. At that time, delete unwanted songs and tracks. Then, start recording again.
- When using Auto Chord Progression and One Two Play in your recording, start recording after adjusting all panel settings in Song Mode prior to activating the "record standby" condition.
- When recording was done with the registration memory button set to ON, the registration memory button lamp will turn off during playback but the contents of that registration will be evident on playback.
- During Rhythm/Auto Orchestra, pressing the song select button for entering song mode and for leaving song mode to return to the normal mode, will stop ongoing Rhythm/Auto Accompaniment.
- When using the damper pedal to play a song recorded with SPLIT (refer to p. 11), the damper effect will conform to system mode damper pedal settings.

18 MIDI INTERFACE

The term MIDI is an acronym for Musical Instrument Digital Interface. MIDI is an international music standard used for sending music data back and forth by way of the custom cables between musical instruments such as digital pianos, synthesizers and sequencers. Utilizing MIDI allows a performance on one musical instrument to be played on several instruments. Plus, the DATA from that performance can be sent to an external sequencer for editing overdubbing, and later playback. The potential uses of MIDI are varied and extremely powerful.

1. MIDI Connections

Musical instruments compatible with MIDI have connection terminals referred to as MIDI IN, MIDI OUT and MIDI THRU (some instruments do not have a MIDI THRU terminal). Custom MIDI cables are inserted into these terminals for compatible MIDI operation between instruments.

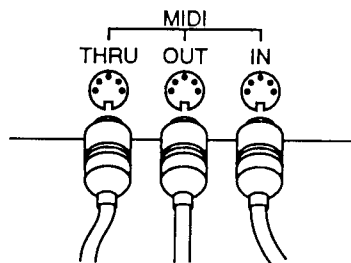

- MIDI OUT Music data transformed into electrical signals are output through this terminal. It is connected to the MIDI IN terminal of other instruments.
- MIDI IN This terminal is an input for receiving music data from other instruments. It is connected to the MIDI OUT or MIDI THRU terminals of other instruments.
- MIDI THRU Data received via the MIDI IN terminal is routed "as is" from this terminal. The MIDI THRU terminal is sometimes used when connecting three or more instruments.

2. Applications of MIDI functions

The types of data sent and received with MIDI vary depending on the musical instrument. This digital piano is provided with the following MIDI functions:

- Setting for send and receive channels
- Sending and receiving keyboard note data (which key is pressed?)
- Sending and receiving of sound change data
- Send and receiving of ON/OFF data for left pedal and damper pedal
- Local control settings (No sound is issued if keys are pressed, sounds can only be heard when the MIDI signal is received.)
- MULTI TIMBRE ON/OFF settings
- Transmission of auto accompaniment data
- ON/OFF for each receive channel while MULTI-TIMBRE is set to ON.

- A 16-section MULTI-TIMBRE GM (General MIDI) sound source can be used since this digital piano is compatible with the international, standardized GM specification.
- During system settings in this unit (refer to p. 33) or during song mode (refer to p. 50), no sound will be generated even if MIDI data is received.

3. What's a MIDI Channel?

Channels are provided in MIDI for simultaneous play of several musical instruments. If the MIDI channels of the transmitting (sending) instrument and receiving instrument do not match, data cannot be exchanged. For example, if three instruments are as shown in the drawing below, and the keys of the A instrument are played, the C instrument will sound simultaneously with A, but the B instrument which is on a different channel will not make any sound.

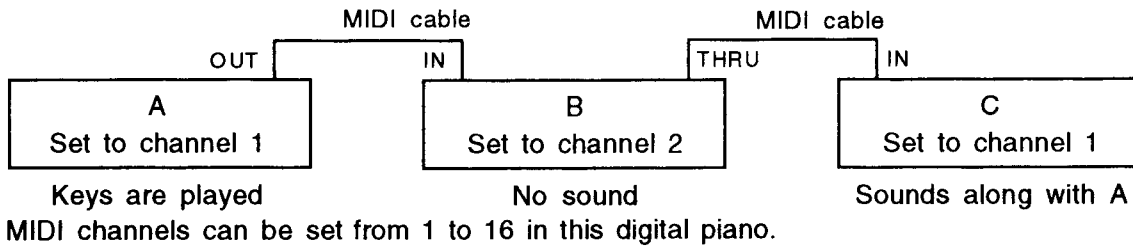

4. Actual MIDI Connection Example

- Connecting with a MIDI-compatible instrument
(Connection to a Kawai K-11 Digital Synthesizer/GMega Synthesizer Module)

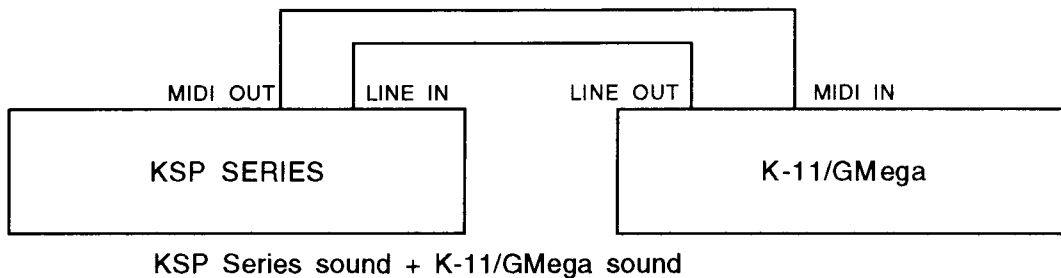

As shown in the above figure, note data created on the KSP series piano (when keys are pressed) is sent to the synthesizer (in this case, a K-11). In addition, the sound from the synthesizer/module can be combined with the KSP piano's sound by connecting the LINE OUT of the synthesizer/sound source to the KSP series LINE IN.

Since the sounds can be set separately, the string sound of the synthesizer/module can be added to the KSP series piano sound for a rich, combined sound. A wide variety of combination sounds can be created in this way.

Please read the respective instruction manuals for operation and handling of the K-11/GMega.

- External sequencer connections
(Connection to a Kawai Q-55 Sequencer)

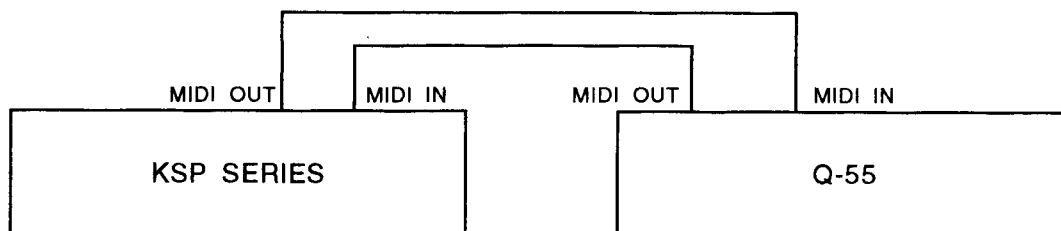

As shown in the figure, this connection allows a performance on the KSP series to be recorded on an external sequencer. If the equipment is equivalent to a Kawai Q-55 Sequencer, Q-80 or Q-80EX sequencer with floppy disk drive, the data from your performance can be stored on a floppy disk. Also, if the sequencer uses standard MIDI files as do the Q-55 and Q-80EX, the performances can be played back on a commercially available song disk (GM sound source, standard MIDI file format).

Please read the sequencer instruction manual for operation and handling procedures for the sequencer.

Regarding MIDI Auto Orchestra

When rhythm and Auto Orchestra are played on this digital piano, the MIDI accompaniment data is simultaneously sent through MIDI on the transmit channels shown in the table below:

	Part	MIDI transmit channel
Auto Orchestra	Drum/percussion	10
	Bass	3
	Chord1	4
	Chord2	5
	Chord3	7

Actual played note data is sent via MIDI on the designated system channel.
(Refer to p. 44)

When the MIDI receive device is a MULTI TIMBRE GM sound source, the Auto Orchestra parts from this digital piano can be played, on that sound source.

- Moving the part volume slider of the Auto Orchestra transmits MIDI volume data through the MIDI transmit channels listed in the table above.
- When recording Auto Orchestra parts on the Q-80(EX), set the Q-80(EX) clock to INT.

Regarding Exclusive Data

In this digital piano, MIDI system exclusive data can be sent or received on the system channels.
(Refer to p. 44)

TRANSMISSION OF PROGRAM CHANGES

When sound buttons are pressed, program change information is sent via MIDI as follows:

Sound Buttons	Program Change Number	
	MULTI TIMBRE - ON	MULTI TIMBRE - OFF
PIANO	0	0
E.PIANO	5	1
VIBES	11	2
DRAWBARS	16	3
PIPES	19	4
CHOIR	52	5
BRASS	61	6
STRINGS	49	7
SAX	65	8
HARMONICA	22	9
FLUTE	73	10
GUITAR	24	11
TONE A	Note 1	12
TONE B		13
TONE C		14
DRUMS	Note 2	15

Note 1 : Corresponds to GM sounds assigned to each button.
(Refer to the back cover page of Auto Chord Progression Chart.)

Note 2 : Corresponds to drum sets assigned to drum buttons.
(Refer to p. 43 of Auto Chord Progression Chart.)

With MULTI TIMBRE ON or GM ASSIGN ON, pressing the sound button sends the program change for the matching GM sound assigned to each button.

FACTORY SETTINGS

SYSTEM SETTINGS

Selected tone color	piano
Tone button A	058 Trombone
Tone button B	106 Banjo
Tone button C	022 Accordion
Tone button DRUMS	DR1 STANDARD
Reverb type	LARGE ROOM
Transpose	± 0
Selected rhythm pattern	POPS 1
Range select	NORMAL

1 Touch curve	NORMAL
2 Left pedal	SOFT
3 Damper pedal	LOWER & UPPER
4 DUAL/SPLIT balance	100 : 100
5 SPLIT point	G # 3
6 Reverb depth	HI = 7 LO = 1
7 Reverb depth in each part	D, C, K = HI B = LO
8 Local control	ON
9 System tuning	± 0
10 Temperament	TYPE = 1, KEY = C
11 ALL GM Assign	OFF
12 System channel	1
13 MIDI clock	INT
14 MULTI TIMBRE	ON
15 Section mute	All channels = Receive

ERROR MESSAGES

Sometimes, when an incorrect operation has been carried out, an error message is displayed on the screen.

TRACK DELETE
no data !

..... Track Delete was attempted while there was no data in the recorder.

Memory full!

..... The record data space in the memory is full and no further recording is possible.
(Delete unwanted track and song data.)
(Refer to p. 57)

WAIT, IT'S NOT BROKEN!

SYMPTOM	CAUSE	TROUBLESHOOTING
No sound, low sound	Volume is set to minimum. (min.).	Set the volume for master volume, rhythm, chord and bass to the correct level.
	Headphones are plugged in.	Remove the headphones so that sound can come from the speakers.
	A registration in which volume was set to min. was recalled.	This volume setting is cancelled when the volume is changed.
	Local control is set to OFF, UPPER OFF.	Set the Local Control to ON. (Refer to p. 40)
Rhythm/Auto Orchestra won't start.	MIDI clock is set to EXT.	Set the MIDI clock to INT. (Refer to p. 45)
Only 1 sound is played in DUAL mode or SPLIT mode.	Low setting for DUAL/SPLIT BALANCE.	Adjust the settings for DUAL/SPLIT BALANCE.
SYSTEM, SONG mode cannot be selected.	Has been set to another mode.	Enter each desired mode when the current mode finishes.
No sound heard, even when MIDI signal is received.	Transmit and receive MIDI channels do not match.	Set transmit and receive to the same MIDI channel.
	Errors in mute section settings were made.	Reset the section mute correctly. (Refer to p. 48)
	System mode or song mode was selected.	Cancel this mode.

MAIN SPECIFICATIONS

Number of keys	76 keys (KSP5) / 88 keys (KSP10)
Polyphonic	32
Sound buttons (16 buttons, 128 sounds, 7 drum sets)	Piano, Electric Piano, Vibraphone, Drawbar Organ, Pipe Organ, Choir, Brass, Strings, Sax, Harmonica, Flute, Guitar, Tone A, Tone B, Tone C, Drums [LOWER only] Wood Bass, Fingered Bass, Fretless Bass, Pad 1, Pad 2, Pad 3
Rhythm (64 rhythms)	Pops 1 x 2, Pops 2 x 2, 8 Beat x 2, 16 Beat x 2, Rock n Roll x 2, Shuffle x 2, Blues x 2, Oldies x 2, Dance x 2, Soft Rock x 2, Boogie x 2, Showbeat x 2, Folk x 2, Bluegrass x 2, Country x 2, Country Pop x 2, Swing x 2, Dixieland x 2, New Orleans x 2, Big Band x 2, Samba x 2, Latin x 2, Jamaica x 2, Paradise x 2, Waltz x 2, European Waltz x 2, Polka x 2, March x 2, Bossanova x 2, Gospel x 2, Salsa, Mambo, Tango, Beguine.
Reverb type	Small room, large room, hall, church, cosmic, delay
Sequencer	Record, playback (10 songs x 3 tracks), delete
Volume	Master volume, rhythm volume, bass volume, chord volume
Other functions	Auto Orchestra, Auto Melody Chord, Auto Chord Progression, DUAL, SPLIT, system settings, transpose, One Two Play, Auto FILL-IN, registration memory
Pedal	Left pedal (soft, start/stop, intro/ending, FILL-IN 1-2 assignments can be done by pedal assign function) damper pedal (upper & lower, lower, upper)
External terminals	Headphones x 2 (Headphones x 1 : KSP5), MIDI (IN, OUT, THRU), LINE IN(L, R), LINE OUT(L, R)
Finish	Cosmo Black (KSP5) / Simulated Dark Walnut (KSP10)
Output	20W x 2 (KSP5) / 30W x 2 (KSP10)
Speaker	12cm x 2, 5.5cm x 2 (KSP5) / (23cm x 16cm) x 2, 5cm x 2 (KSP10)
Dimensions (W x D x H)	KSP5 : 121 x 47 x 81 (cm) (with stand) / KSP10 : 140 x 49 x 81 (cm) (with stand)
Weight	45 kg / 58 kg
Accessories	Owner's manual (Basic Operation), Owner's manual (Advanced Operation), Auto Chord Progression Chart, etc.

INDEX

All GM ASSIGN	43	Reset	32
Auto Accompaniment	17	Reverb	13
Auto Chord Progression	23	Reverb Depth	38
Auto FILL-IN	27	Reverb Depths, Parts	39
Auto Melody Chord	26	Reverb Type	14
Auto Orchestra	17	Rhythm	15
Cent	41	Rhythm Select	15
Chord Form		Section Mute	48
→ Auto Chord Progression Chart		Song Delete	57
Cursor	9	Song Mode	50
Damper pedal setting	35	Song Select	50
Demo	31	Sound list	
Drum Set	8	→ Auto Chord Progression Chart	
Drums Key Assign Table		SPLIT Function	11
→ Auto Chord Progression Chart		SPLIT Point	37
DUAL Function	10	Start/Stop	16
DUAL/SPLIT Balance	36	System	33
Error Message	64	System Channel	44
Exclusive Data	61	System Tuning	41
Factory settings	47, 63	Temperament	42
FILL-IN	16, 20	Tempo	9
Fingered	17, 19	Touch Curve	33
GM (General MIDI)	47, 59	Track	49, 56
Intro/Ending	16, 20	Track Delete	57
Left Pedal Setting	34	Transpose	28
Local Control	40	Tuning	41
Lower keyboard	17, 18, 37	Value	7
MIDI	59	Whole Keyboard	17, 19
MIDI Channel	44		
MIDI Clock	45		
MIDI Implementation Chart	68		
MULTI-TIMBRE	46		
Multiple Track Recording	53		
One Finger	17, 19		
One Two Play	25		
Part Reverb Depths	39		
Pedal Assign	34, 35		
Play/Stop	51		
Program Change	62		
Program Number List			
→ Auto Chord Progression Chart			
Range Select	22		
Recorder	49		
Registration Memory	29		

Model KSP5 / 10 MIDI Implementation Chart

Function		Transmit	Receive	Remarks
Basic channel	When power is ON Possible settings	1, 3, 4, 5, 10 ★1 1-16 ★2	1-16 1-16 ★3	★3 At MULTI TIMBRE ON, channels 1 - 16 are set in each section.
Mode	When power is ON Message Alternative	3 × *****	3 × ×	
Note number	Sound range	16-115(KSP5), 9-120(KSP10) *****	0-127 0-127	
Velocity	Note ON Note OFF	○ 9nH V=1-127 × 9nH V=0	○ ×	
After touch	Keys Channel	× ×	× ○	
Pitch bender		○ ★4	○	
Control change	1	○ ★4	○	Modulation
	6	×	○	Data entry
	7	○	○	Volume
	10	○ ★4	○	Panpot
	11	○ ★4	○	Expression
	64	○	○	Hold 1 (Sustain)
	67	○	○	Soft pedal
	69	×	○	Hold 2 (Sustain)
	91	×	○ (LO/Hi)	Effect
	100,101	×	○	RPN, LSB, MSB
120	×	○	All sound off	
121	×	○	Reset · all controllers	
Program change	Setting range	○ (0-127) *****	○ (0-127) ★5 (0-127)	★5 10ch: Receive only of 0-6, 8, 16, 24, 25, 33, 40, 48
Exclusive		○	○	
Common	: Song position	×	×	
	: Song select	×	×	
	: Chain	×	×	
Real time	: Clock	○	○	
	: Command	○	○	
Others	: Local ON/OFF	×	○ (Receive only of system channels)	
	: All Note OFF	×	○	
	: Active sensing	○	○	
	: Reset	×	×	
Remarks	★1 1 = keyboard, 3 = bass ★2 keyboard parts only 4 = chord 1, 5 = chord 2 7 = chord 3, 10 = drum			★4 Transmit only at auto accompaniment

Mode 1 : Omni On, Poly
Mode 3 : Omni Off, Poly

Mode 2 : Omni On, Mono
Mode 4 : Omni Off, Mono

○ : Function
× : None

KAWAI

Kawai Musical Instruments Manufacturing Co., Ltd.
200 Terajima-cho, Hamamatsu, Japan